

ProChipper®

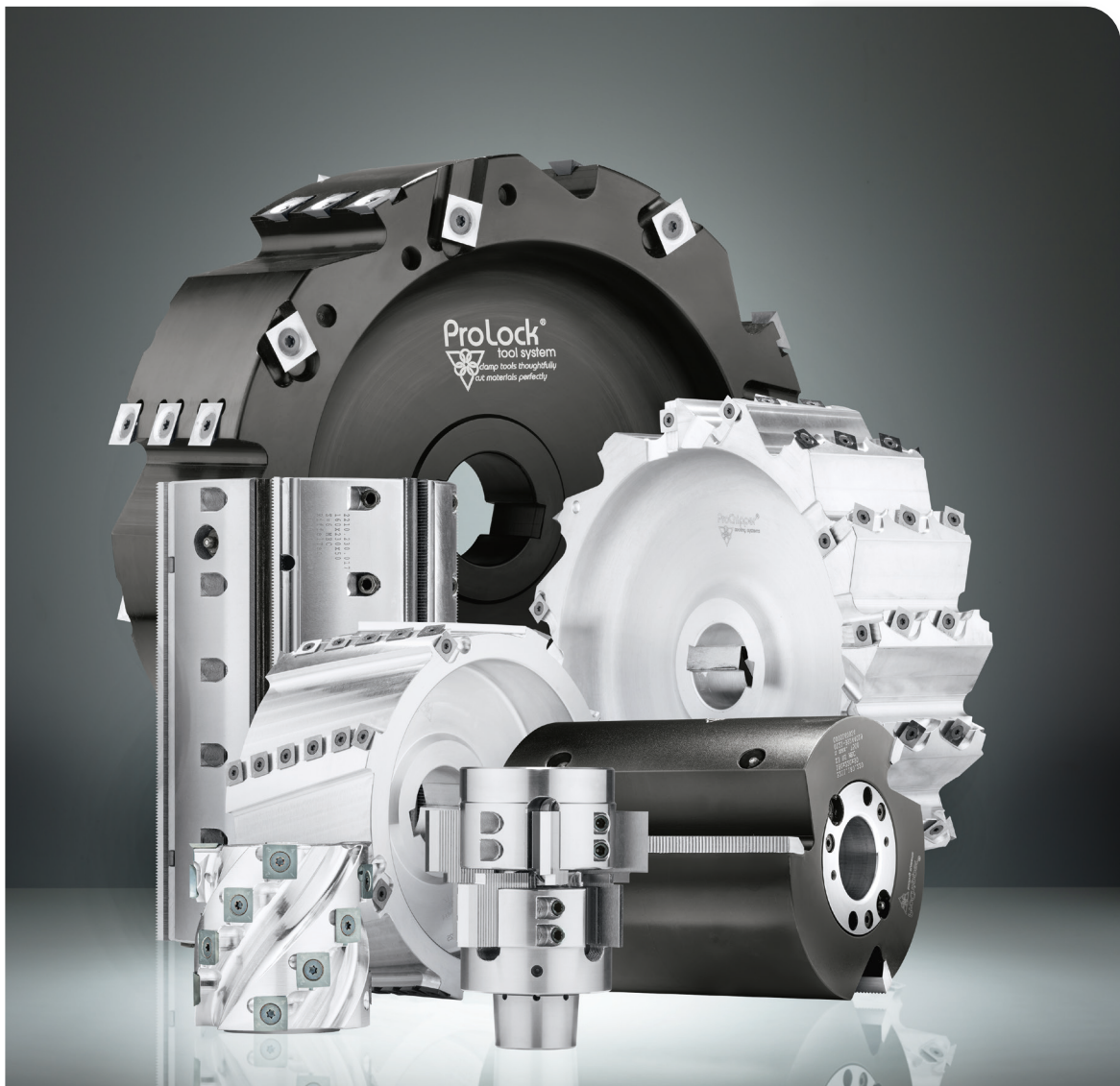

tooling systems



Fräswerkzeuge mit Bohrung, nicht profiliert
Tools with bore, straight

4149

HW Nutfräser mit Vorschneidern - Wendemesser
TC Grooving cutter - Reversible knife

PG
02

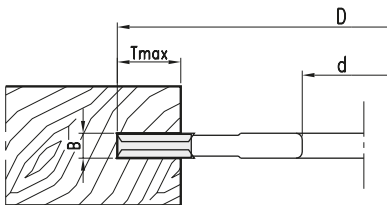
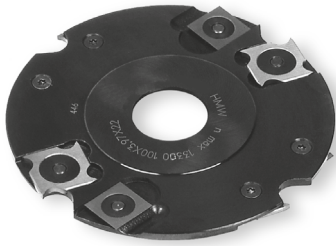

WP-Nutfräser für Handvorschub
Grooving cutter with reversible knives for manual feed

MAN

HW

D	B	d	Z	V	Tmax.	n min - n max	Art. Nr.
120	4	20/30	4	4	27	6400-11100	4149.120.004
	5	20/30	4	4	27	6400-11100	4149.120.005
	6	20/30	4	4	27	6400-11100	4149.120.006
140	4	30/50	4	4	32	5500-9500	4149.140.004
	5	30/50	4	4	32	5500-9500	4149.140.005
	6	30/50	4	4	32	5500-9500	4149.140.006

Wechselmesser/Ersatzteile
Reversible knife/Spare parts

	Dim.	B	Art. Nr.
Wendemesser - <i>Reversible knife</i>	18x18x1,95	4	766.101
	18x18x2,45	5	766.102
	18x18x2,95	6	766.103
Ring - <i>Nut</i>	11,9x1,7	4	709.129
	11,9x2,2	5/6	709.127
Vorschneider - <i>Spur</i>	14x14x1,2	4/5/6	750.113
	9,9x1,6	4/5/6	709.128
Spannschraube - <i>Screw</i>	M4x3,2	4	705.313
	M4x4,2	5/6	705.314
Torx Schlüssel - <i>Torx wrench</i>	T9		706.301

5149

HW Nutfräser mit Vorschneidern - Wendemesser
TC Grooving cutter - Reversible knife

PG
02

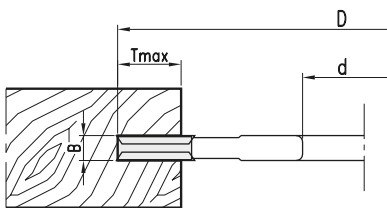
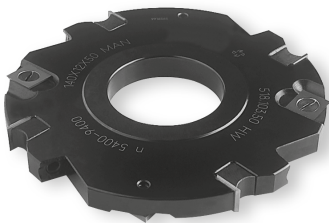

WP-Nutfräser für Handvorschub
Grooving cutter with reversible knives for manual feed

MAN

HW

D	B	d	Z	V	Tmax.	n min - n max	Art. Nr.
140	8	30/50	4	4	32	5500-9500	5149.140.008
	10	30/50	4	4	32	5500-9500	5149.140.010
	12	30/50	4	4	32	5500-9500	5149.140.012
	15	30/50	4	4	32	5500-9500	5149.140.015

Wechselmesser/Ersatzteile
Reversible knife/Spare parts

	Dim.	B	Art. Nr.
Wendemesser - <i>Reversible knife</i>	7,5x12x1,5	8	750.097
	9,6x12x1,5	10	750.098
	11,6x12x1,5	12	750.099
	14,6x12x1,5	15	750.201
Spanneil - <i>Clamping wedge</i>		8	707.002.07
		10	707.002.08
		12	707.002.10
		15	707.002.13
Spannschraube - <i>Screw</i>	M5x16	8	705.582
	M6x16	10	705.535
	M8x16	12/15	705.542
Vorschneider - <i>Spur</i>	14x14x2		750.111
	Spannschraube - <i>Screw</i>	M5x6	8/10
		M5x8	12/15
Sechskantschlüssel - <i>TWrench</i>	SW2,5 (M5)		705.102
	SW3 (M6)		705.103
	SW4 (M8)		706.104
Einstell-Lehre - <i>Gauge</i>		0,3/0,8	717.309

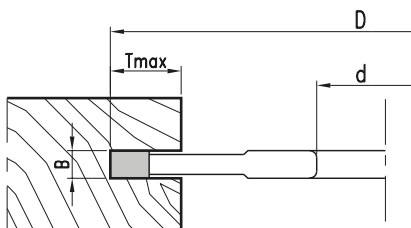
8139**HW Nutfräser Z=4 - Festbestückt**
TC Grooving cutter Z=4 - Tipped**PG**
02**HW-Bestückter Nutfräser für Handvorschub**
TC-tipped grooving cutter for manual feed**MAN****HW**

D	B	d	Z	Tmax.	n min - n max	Art. Nr.
140	4	30/50	4	32	5500-9500	8139.140.004
	5	30/50	4	32	5500-9500	8139.140.005
	6	30/50	4	32	5500-9500	8139.140.006
	7	30/50	4	32	5500-9500	8139.140.007
	8	30/50	4	32	5500-9500	8139.140.008
	10	30/50	4	32	5500-9500	8139.140.010
	12	30/50	4	32	5500-9500	8139.140.012
	14	30/50	4	32	5500-9500	8139.140.014
	16	30/50	4	32	5500-9500	8139.140.016
	18	30/50	4	32	5500-9500	8139.140.018
	20	30/50	4	32	5500-9500	8139.140.020
	25	30/50	4	32	5500-9500	8139.140.025

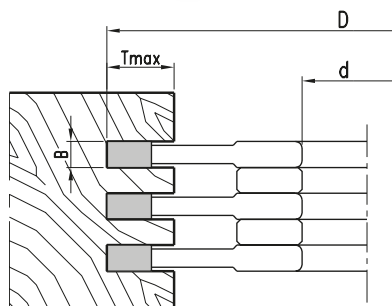
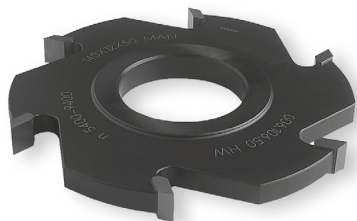
8139**HW Nutfräser Z=6 - Festbestückt**
TC Grooving cutter Z=6 - Tipped**PG**
02**HW-Bestückter Nutfräser für Handvorschub**
TC-tipped grooving cutter for manual feed**MAN****HW**

D	B	d	Z	Tmax.	n min - n max	Art. Nr.
140	4	30/50	6	32	5500-9500	8139.140.104
	5	30/50	6	32	5500-9500	8139.140.105
	6	30/50	6	32	5500-9500	8139.140.106
	7	30/50	6	32	5500-9500	8139.140.107
	8	30/50	6	32	5500-9500	8139.140.108
	10	30/50	6	32	5500-9500	8139.140.110
	12	30/50	6	32	5500-9500	8139.140.112
	14	30/50	6	32	5500-9500	8139.140.114
	16	30/50	6	32	5500-9500	8139.140.116
	20	30/50	6	32	5500-9500	8139.140.120

01



02



03



04



05



06



07



08



09



10



11

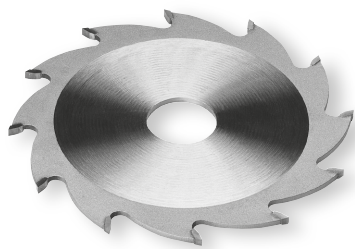

8434**HW Nutfräser Z=12, Z=24 - Festbestückt**
TC Grooving cutter Z=12, Z=24 - Tipped**PG
02****HW-Bestückter Nutfräser für mechanischen Vorschub**
TC-tipped grooving cutter for mechanical feed**MEC****HW**

D	B	b	d	Z	Art. Nr.
150	2,5	1,8	30	12	8434.150.003
	3,0	2,0	30	12	8434.150.103
	3,5	2,5	30	12	8434.150.004
	4,0	2,8	30	12	8434.150.104
	4,5	3,5	30	12	8434.150.005
	5,0	3,5	30	12	8434.150.105
	6,0	3,9	30	12	8434.150.006
150	8,0	6,0	30	12	8434.150.008
	10,0	7,0	30	12	8434.150.010
	2,5	1,8	30	24	8434.150.203
	3,0	2,0	30	24	8434.150.303
	3,5	2,5	30	24	8434.150.204
	4,0	2,8	30	24	8434.150.304
	4,5	3,5	30	24	8434.150.205
150	5,0	3,5	30	24	8434.150.305
	6,0	3,9	30	24	8434.150.106

- Zahnbreite mit beidseitigem Überstand.
- Gehärteter Stahlgrundkörper.
- Cutter with tooth overhang and hardened toolbody.

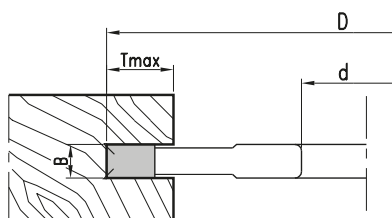
8149**HW Nutfräser mit Vorschneidern - Festbestückt**
TC Grooving cutter with spurs - Tipped**PG
02****HW-Bestückter Nutfräser mit Vorschneidern für Handvorschub**
TC-tipped grooving cutter with spacers for manual feed**MAN****HW**

D	B	d	Z	V	Tmax	n min - n max	Art. Nr.
140	4	30/50	4	4	32	5500-9500	8149.140.004
	5	30/50	4	4	32	5500-9500	8149.140.005
	6	30/50	4	4	32	5500-9500	8149.140.006
	8	30/50	4	4	32	5500-9500	8149.140.008
	10	30/50	4	4	32	5500-9500	8149.140.010
	12	30/50	4	4	32	5500-9500	8149.140.012
	16	30/50	4	4	32	5500-9500	8149.140.016
	18	30/50	4	4	32	5500-9500	8149.140.018
	20	30/50	4	4	32	5500-9500	8149.140.020
	25	30/50	4	4	32	5500-9500	8149.140.025
160	4	30/50	4	4	32	4800-8300	8149.160.004
	5	30/50	4	4	32	4800-8300	8149.160.005
	6	30/50	4	4	32	4800-8300	8149.160.006
	8	30/50	4	4	32	4800-8300	8149.160.008
	10	30/50	4	4	32	4800-8300	8149.160.010
	12	30/50	4	4	32	4800-8300	8149.160.012
	16	30/50	4	4	32	4800-8300	8149.160.016
	18	30/50	4	4	32	4800-8300	8149.160.018
	20	30/50	4	4	32	4800-8300	8149.160.020

HW-Bestückter Nutfräser für mechanischen Vorschub
TC-tipped grooving cutter for mechanical feed
MEC**HW**

D	B	D	Z	Art. Nr.
70	5	32	8	8174.070.005
	6	32	8	8174.070.006
72	5	32	8	8174.072.005
	6	32	8	8174.072.006
74	5	32	8	8174.074.005
	6	32	8	8174.074.006
80	5	32	8	8174.080.005
	6	32	8	8174.080.006
98	5	32	10	8174.098.005
	6	32	10	8174.098.006
100	5	32	10	8174.100.005
	6	32	10	8174.100.006
110	5	32	12	8174.110.005
	6	32	12	8174.110.006
112	5	32	12	8174.112.005
	6	32	12	8174.112.006
114	5	32	12	8174.114.005
	6	32	12	8174.114.006
70	6	32	12	◇ 8174.070.106
72	6	32	12	◇ 8174.072.106
74	5	32	12	◇ 8174.074.105
	6	32	12	◇ 8174.074.106
80	5	32	12	◇ 8174.080.105
	6	32	12	◇ 8174.080.106
98	5	32	12	◇ 8174.098.105
	6	32	12	◇ 8174.098.106
100	5	32	12	◇ 8174.100.105
110	5	32	16	◇ 8174.110.105
	6	32	16	◇ 8174.110.106
112	5	32	16	◇ 8174.112.105
	6	32	16	◇ 8174.112.106
114	5	32	16	◇ 8174.114.105
	6	32	16	◇ 8174.114.106

- ◇ Serienartikel, kurzfristige Fertigung bei Bestellung
- ◇ *Standard article, short-time production after order*

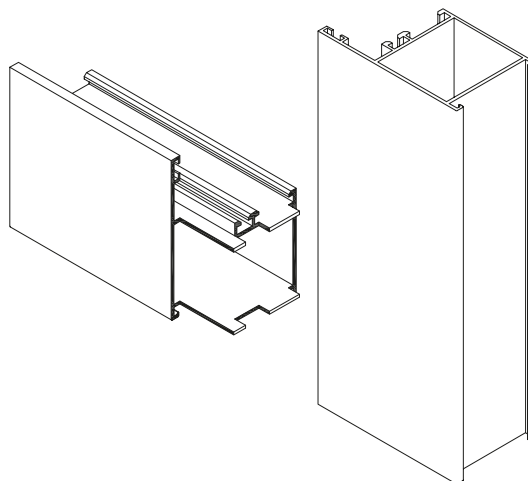

8239

HW „Lamello“-Nutfräser - Festbestückt

TC Grooving cutter for „lamello“ machine - Tipped

PG
02

HW-Bestückter Nutfräser für Handvorschub mit Lamello-Maschine
TC-tipped grooving cutter for manual feed lamello machine

MAN

HW

D	B	b	d	Z	ML/TK	n min - n max	Art. Nr.
100	3,97	2,8	22	6	4/4,5/36	7800-13300	8239.100.006
100	3,97	2,8	22	8	4/4,5/36	7800-13300	8239.100.008
100	3,97	3,0/3,5	22	12		7800-13300	2353.200.22

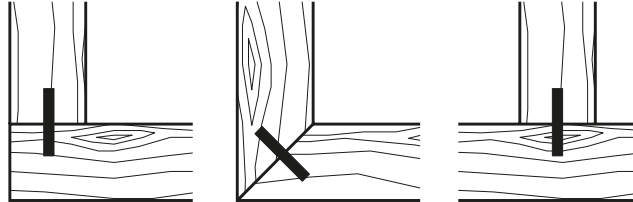

4249

HW „Lamello“-Nutfräser mit Vorschneidern - Wendemesser

TC Grooving cutter for „lamello“ machine - Reversible knife

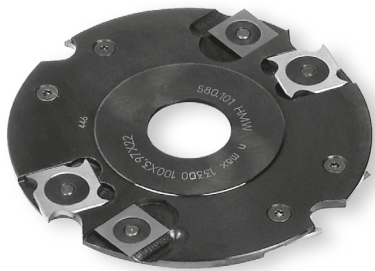
PG
02

WP-Nutfräser für Handvorschub mit Lamello-Maschine
Grooving cutter with reversible knives for manual feed with lamello machine

MAN

HW

D	B	d	Z	V	n min - n max	Art. Nr.
100	3,97	22	4	4	7800-13300	4249.100.004

Wechselmesser/Ersatzteile
Reversible knife/Spare parts

	Dim.	Art. Nr.
Wendemesser - Reversible knife	18x18x1,95	766.101
Ring - Nut	11,9x1,7	709.129
Vorschneider - Spur	14x14x1,2	750.113
Ring - Nut	9,9x1,6	709.128
Spannschraube - Screw	M4x3,2	705.313
Torx Schlüssel - Torx wrench	T9	706.301

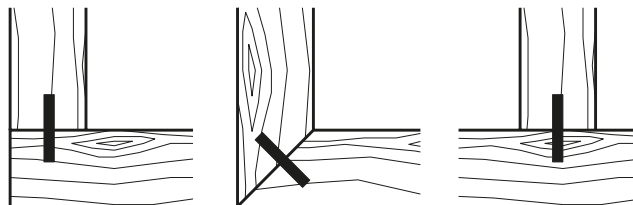

5274

HW Nutenbetfräser mit Vorschneidern - Wendemesser
TC Groovingbed cutter - Reversible knife

PG
02

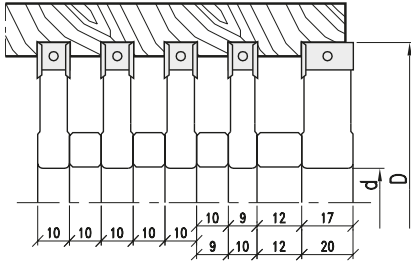

WP-Nutfräser für mechanischen Vorschub
Grooving cutter with reversible knives for mechanical feed

MEC

HW

D	B	d	Z	V	n max	Art. Nr.
125	9	40	2	2	11500	5274.125.009
	10	40	2	2	11500	5274.125.010
	17	40	2	2	11500	5274.125.017
	20	40	2	2	11500	5274.125.020
150	12	40	3	3	8900	5274.150.012

Wechselmesser/Ersatzteile
Reversible knife/Spare parts

	Dim.	B	Art. Nr.
Wendemesser - <i>Reversible knife</i>	8,6x12x1,5	9	750.095
	9,6x12x1,5	10	750.098
	12x12x1,5	12	754.102
	17x12x1,5	17	750.115
	20x12x1,5	20	750.102
Spanneil - <i>Clamping wedge</i>		9/10	707.002.08
		17	707.002.15
		20	707.002.18
Gewindestift - <i>Screw</i>	M6x12	9/10	705.533
	M8x16	17/20	705.542
Vorschneider - <i>Spur</i>	14x14x12		750.111
Spannschraube - <i>Screw</i>	M5x6	9/10	705.424
	M5x7	12	705.425
Zwischenring - <i>Spacers</i>		9	703.411
		10	703.412
		12	703.413
Sechskantschlüssel - <i>T Wrench</i>	SW3(M6)		706.103
	SW4(M8)		706.104
Einstell-Lehre - <i>Gauge</i>		0,3/0,8	717.309

8839

HW Verstellnuter - Festbestückt
TC Adjustable grooving cutter - Tipped

PG
02

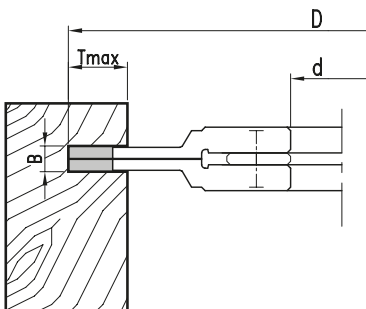
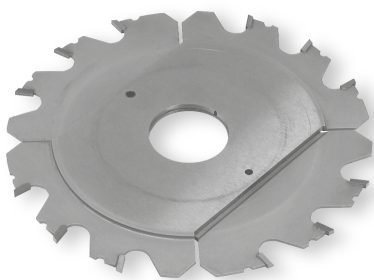

HW-bestückter Nutfrässatz für Handvorschub, mit Zwischenringen verstellbar.
TC-tipped grooving cutterset for manual feed, adjustable with spacers.

MAN

HW

D	B	d	Z	Tmax.	n min - n max	Art. Nr.
120	1,8-3,4	30	6+6	12	6400-11100	8839.120.002
	2,2-4,0	30	6+6	15	6400-11100	8839.120.102
140	2,2-4,0	50	6+6	15	5500-9500	8839.140.002
220	3,5-6,5	50	20+20	17	3500-6000	8839.220.004

- Inklusive Zwischenring-Satz
- *Spacerset included*



- Kombination von Einzelfräsern zum Fräsen der jeweiligen Kantenge triebe-Profile.
- *Combination of single cutters to machine closure fittings*

WP-Profilnuffräser für Handvorschub.
Profile grooving cutter for manual feed.

MAN

HW

Nr.	D	B	d	Z	V	I	n min - n max	Art. Nr.
1	136	15	50	2		2	5700-9800	5289.136.015
2	180	22	50	2	4		4200-7200	5289.180.022
3	136	15	50	2		2	5700-9800	5289.136.115
4	220	22	50	2+2	4+4		3500-6000	5289.220.022
5	244	22	50	2			3100-5300	5289.244.022
6	200	22	50	2+2	8		3900-6900	5289.200.022
7	220	22	50	2+2	8		3500-6300	5289.220.122
8	224	22	50	2	2	2	3400-6200	5289.224.022
9	136	30	50	2	2	2/2	5700-10200	5289.136.030
10	198	22	50	2+2	8		3900-7000	5289.198.022
11	136	10	50	2	2	2	5700-10200	5289.136.010
12	144	20	50	2			5400-9600	5289.144.020
13	222	22	50	2	4		3500-6200	5289.222.022
14	182	26	50	2	2		4300-7600	5289.182.026
15	171	60	50	2		2	4800-8700	5289.171.060

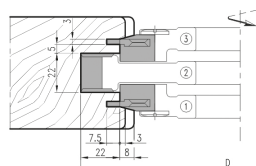

GU-System
934/937

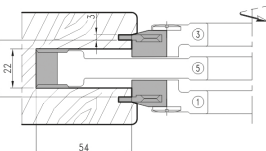
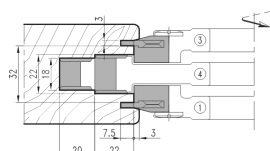

Maco-System
HS15 / 25 performance

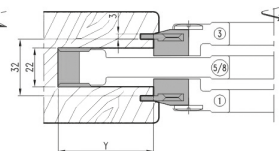
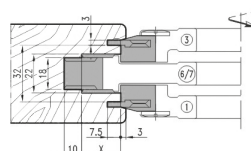
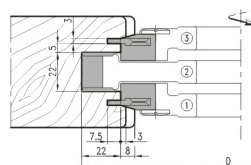
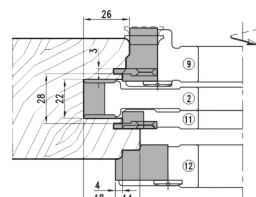
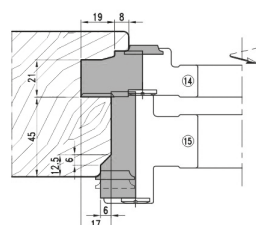
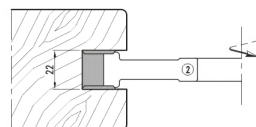
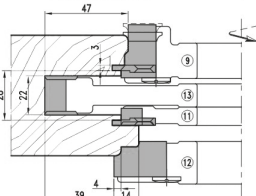
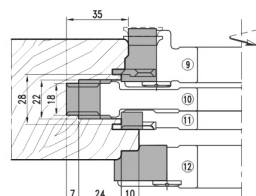

Wendemesser/Ersatzteile
Reversible knife/Spare parts

	Dim.	Nr.	Art. Nr.
Wendemesser - <i>Reversible knife</i>	9,6x12x1,5	11	750.098
	15x12x1,5	1	785.781
	15x12x1,5	3	785.782
	17,6x12x1,5	10/4/6/7	750.205
	21,6x12x1,5	2/4/5/8/10/13	750.204
	30x20x2	9	785.800
Spannkeil - <i>Clamping wedge</i>	20x30x2	12	785.670
	26x35x2	14	785.671
	60x25x2	15	785.672
		11	707.002.08
		1	707.281
		3	707.282
		4/6/7/10	707.002.15
		2/4/5/10/13	707.002.20
		9	707.553
		12	707.596.01
		14	707.596.02
Gewindestift - <i>Screw (DIN915)</i>	M6x16	11	705.535
	M8x16		705.542
Vorschneider - <i>Spur</i>	14x14x2		750.111
Spannschraube - <i>Screw (DIN963)</i>	M5x8		750.422
Nutmesser - <i>Grooving knife</i>	35x17x3	1/3/9/11	783.109
Schraube - <i>Screw</i>	M5x13,5		705.318
Sechskantschlüssel - <i>T Wrench</i>	SW3(M5)		706.103
	SW4 (M8)		706.104

5189

HW Kantengetriebefräser mit Vorschneidern - Wendemesser
TC Closure fittings grooving cutter - Reversible knife

PG
02

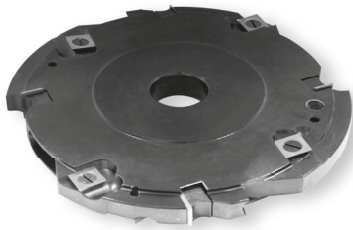

WP-Profilfräser für Handvorschub
Profile grooving cutter with reversible knives for manual feed

MAN

HW

D	B	d	Z	V	n min - n max	Art. Nr.
184	16,3	30/60	2+2	4+4	4200-7200	5189.184.016
194	16,3	30/60	2+2	4+4	4000-6800	5189.194.016
200	16,3	30/60	2+2	4+4	3800-6500	5189.200.016

Wendemesser/Ersatzteile
Reversible knife/Spare parts

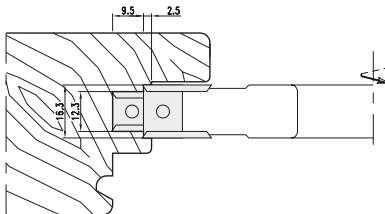

	Dim.	Art. Nr.
Wendemesser - Reversible knife	12x12x1,5	754.102
Spannkeil - Clamping wedge	16x12x1,5	750.206
		707.002.10
		707.002.13
Gewindestift - Screw	M8x16	705.542
Vorschneider - Spur	14x14x2	750.111
Spannschraube - Screw	M5x7	705.425
Sechskantschlüssel - T Wrench	SW4	706.104

8189

HW Schlitzsäge mit Vorschneidern - Festbestückt
TC Slotting cutter - Tipped

PG
02



HW- oder HS-bestückte Schlitzsäge mit Vorschneidern für Handvorschub
TC- or HS-tipped slotting cutter with spurs for manual feed

MAN

HW/HS

D	B	d	Z	V	Tmax.	n min - n max	Art. Nr. HW	Art. Nr. HS
250	18	50	3	3	90	3100-5300	8189.250.018	8189.250.118
	24	50	3	3	90	3100-5300	8189.250.024	8189.250.124
	30	50	3	3	90	3100-5300	8189.250.030	8189.250.130
	40	50	3	3	90	3100-5300	8189.250.040	8189.250.140
300	18	50	3	3	115	2600-4400	8189.300.018	8189.300.118
	24	50	3	3	115	2600-4400	8189.300.024	8189.300.124
	30	50	3	3	115	2600-4400	8189.300.030	8189.300.130
	40	50	3	3	115	2600-4400	8189.300.040	8189.300.140
320	18	50	3	3	125	2400-4100	8189.320.018	8189.320.118
	24	50	3	3	125	2400-4100	8189.320.024	8189.320.124
	30	50	3	3	125	2400-4100	8189.320.030	8189.320.130
	40	50	3	3	125	2400-4100	8189.320.040	8189.320.140

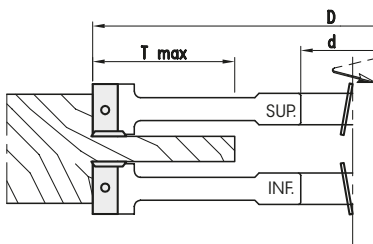

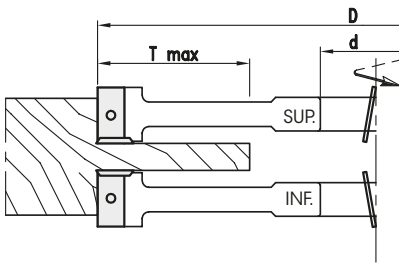
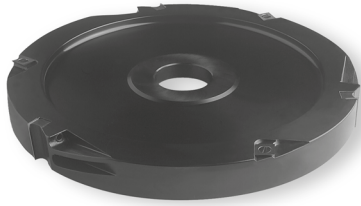

HW- oder HS-bestückte Schlitzscheibe mit Vorschneidern für Handvorschub
TC- or HS-tipped slotting cutter with spurs for manual feed
MAN**HW**

D	B	d	Z	V	Tmax.	n min - n max	Art. Nr. SUP	Art. Nr. INF
250	20	50	3	3	90	3100-3500	5249.250.020	5249.250.120
	25	50	3	3	90	3100-3500	5249.250.025	5249.250.125
	30	50	3	3	90	3100-3500	5249.250.030	5249.250.130
	40	50	3	3	90	3100-3500	5249.250.040	5249.250.140
272	30	50	3	3	100	2800-4900	5249.272.030	5249.272.130
	40	50	3	3	100	2800-4900	5249.272.040	5249.272.140
280	20	50	3	3	105	2800-4700	5249.280.020	5249.280.120
	25	50	3	3	105	2800-4700	5249.280.025	5249.280.125
	30	50	3	3	105	2800-4700	5249.280.030	5249.280.130
	40	50	3	3	105	2800-4700	5249.280.040	5249.280.140
300	20	50	3	3	115	2600-4400	5249.300.020	5249.300.120
	25	50	3	3	115	2600-4400	5249.300.025	5249.300.125
	30	50	3	3	115	2600-4400	5249.300.030	5249.300.130
	40	50	3	3	115	2600-4400	5249.300.040	5249.300.140
302	30	50	3	3	115	2600-4400	5249.302.030	5249.302.130
	40	50	3	3	115	2600-4400	5249.302.040	5249.302.140
320	20	50	3	3	125	2400-4100	5249.320.020	5249.320.120
	25	50	3	3	125	2400-4100	5249.320.025	5249.320.125
	30	50	3	3	125	2400-4100	5249.320.030	5249.320.130
40	50	3	3	125	2400-4100	5249.320.040	5249.320.140	

- Ausführung mit ziehendem Schnitt
- *With axial angle.*

Wendemesser/Ersatzteile
Reversible knife/Spare parts

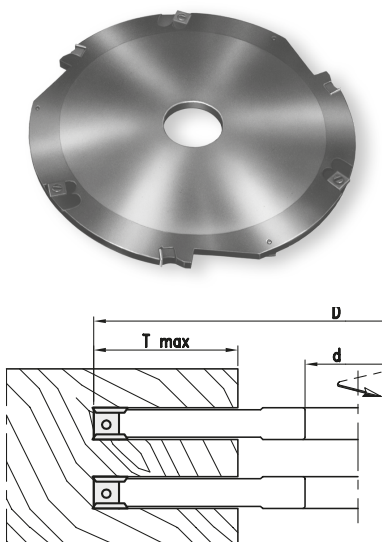
	Dim.	Nr.	Art. Nr.
Wendemesser - <i>Reversible knife</i>	20x12x1,5		750.102
	4,7x12x1,5		750.103
	30x12x1,5		750.104
	40x12x1,5		150.105
Spannkeil - <i>Clamping wedge</i>		INF	707.133.20
			707.133.25
			707.133.30
			707.133.40
		SUP	707.130.20
			707.130.25
			707.130.30
			707.130.40
Gewindestift - <i>Screw</i>	M8x16		705.542
Vorschneider - <i>Spur</i>	14x14x2		750.111
Spannschraube - <i>Screw</i>	M5x7		705.425
Sechskantschlüssel - <i>T Wrench</i>	SW4(M8)		706.104



WP-Schlitzscheibe mit Vorschneidern für Handvorschub
Slotting cutter with reversible knives and spurs for manual feed
MAN
HW

D	B	d	Z	V	Tmax.	n min - n max	Art. Nr.
250	8	30/50	3	6	80	3100-5300	5199.250.008
	10	30/50	3	6	80	3100-5300	5199.250.010
	12	30/50	3	6	80	3100-5300	5199.250.012
	15	30/50	3	6	80	3100-5300	5199.250.015
	20	30/50	3	6	80	3100-5300	5199.250.020
272	8	30/50	3	6	90	2800-4900	5199.272.008
	10	30/50	3	6	90	2800-4900	5199.272.010
	12	30/50	3	6	90	2800-4900	5199.272.012
	15	30/50	3	6	90	2800-4900	5199.272.015
	20	30/50	3	6	90	2800-4900	5199.272.020
280	8	30/50	3	6	95	2800-4700	5199.280.008
	10	30/50	3	6	95	2800-4700	5199.280.010
	12	30/50	3	6	95	2800-4700	5199.280.012
	15	30/50	3	6	95	2800-4700	5199.280.015
	20	30/50	3	6	95	2800-4700	5199.280.020
302	8	30/50	3	6	110	2600-4400	5199.302.008
	10	30/50	3	6	110	2600-4400	5199.302.010
	12	30/50	3	6	110	2600-4400	5199.302.012
	15	30/50	3	6	110	2600-4400	5199.302.015
20	30/50	3	6	110	2600-4400	5199.302.020	

- ◇ Serienartikel, kurzfristige Fertigung bei Bestellung
- ◇ Standard article, short-time production after order

Wendemesser/Ersatzteile
Reversible knife/Spare parts

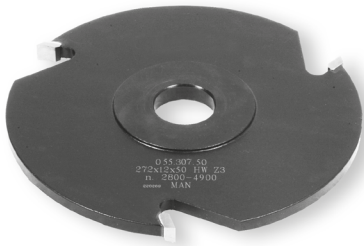
	Dim.	B	Art. Nr.
Wendemesser - <i>Reversible knife</i>	7,5x12x1,5		750.097
	9,6x12x1,5		750.098
	11,6x12x1,5		750.099
	14,6x12x1,5		750.201
	19,6x12x1,5		750.208
Spannkeil - <i>Clamping wedge</i>			707.002.07
			707.002.08
			707.002.10
			707.002.13
Gewindestift - <i>Screw</i>	M5x12	8	705.523
	M6x16	10	705.535
	M8x16	12/20	705.542
Vorschneider - <i>Spur</i>	14x14x2		750.111
Spannschraube - <i>Screw</i>	M5x6	8/10	705.424
	M5x7	12/20	705.425
Sechskantschlüssel - <i>T Wrench</i>	SW2(M5)		706.102
	SW3(M6)		706.103
	SW(M8)		706.104



HW- oder HS-bestückte Schlitzscheibe für Handvorschub
TC- or HS-tipped slotting cutter for manual feed

MAN

HW/HS

D	B	d	Z	Tmax. n min - n max		Art.Nr. HW	Art. Nr. HS
250	8	50	3	90	3100-5300	8199.250.008	8199.250.108
	10	50	3	90	3100-5300	8199.250.010	8199.250.110
	12	50	3	90	3100-5300	8199.250.012	8199.250.112
	15	50	3	90	3100-5300	8199.250.015	8199.250.115
272	8	50	3	100	2800-4900	8199.272.008	8199.272.108
	10	50	3	100	2800-4900	8199.272.010	8199.272.110
	12	50	3	100	2800-4900	8199.272.012	8199.272.112
280	8	50	3	105	2800-4700	8199.280.008	8199.280.108
	10	50	3	105	2800-4700	8199.280.010	8199.280.110
	12	50	3	105	2800-4700	8199.280.012	8199.280.112
302	8	50	3	115	2600-4400	8199.302.008	8199.302.108
	10	50	3	115	2600-4400	8199.302.010	8199.302.110
	12	50	3	115	2600-4400	8199.302.012	8199.302.112
	15	50	3	115	2600-4400	8199.302.015	8199.302.115

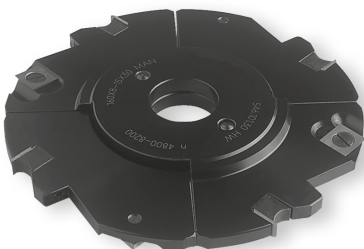
- ◇ Serienartikel, kurzfristige Fertigung bei Bestellung
- ◇ *Standard article, short-time production after order*



WP-Nutfräsersatz für Handvorschub, mit Zwischenringen verstellbar.
Grooving cutterset for manual feed with reversible knives, adjustable with spacers.

MAN

HW

D	B	d	Z	V	Tmax.	n min - n max	Art. Nr.
160	8-15	30/50	4	4	32	4800-8300	5849.160.008
	12,6-24	30/50	4	4	32	4800-8300	5849.160.013
180	8-15	30/50	4	4	38	4300-7400	5849.180.008
	12,6-24	30/50	4	4	38	5300-7400	5849.180.013

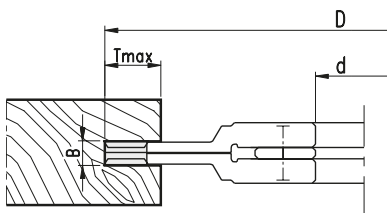
- Inklusive Zwischenring-Satz
- *Spacerset included*



Wendemesser/Ersatzteile
Reversible knife/Spare parts

	Dim.	B	Art. Nr.
Wendemesser - <i>Reversible knife</i>	7,5x12x1,5	8-15	750.097
	12x12x1,5	12,6-24	754.102
Spannkeil - <i>Clamping wedge</i>		8-15	707.002.06
		12,6-24	707.002.10
Gewindestift - <i>Screw</i>	M5x16	8-15	705.582
	M8x16	12,6-24	705.542
Vorschneider - <i>Spur</i>	14x14x2		750.111
Gewindestift - <i>Screw</i>	M5x6	8-15	705.424
	M5x7	12	705.425
Sechskantschlüssel - <i>T Wrench</i>	SW2,5 (M5)		706.102
	SW4 (M8)		706.104
Zwischenringsatz - <i>Spacers set</i>		8-15	703.039
		12,6-24	703.040
Einstell-Lehre - <i>Gauge</i>		0,3/0,8	717.309

4849

HW Verstellnutter mit Vorschneiden - Wendemesser
TC Adjustable grooving cutter - Reversible knife

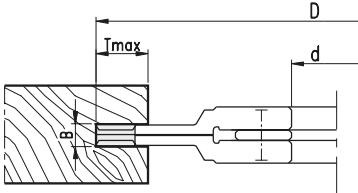
PG
02



Nutbreite • Grooving width
 4-7,5: 2-teilig • 2-part construction
 4-15: 3-teilig • 3-part construction

WP-Nutfräsersatz für Handvorschub, mit Zwischenringen verstellbar.
Grooving cutterset for manual feed with reversible knives, adjustable with spacers

MAN

HW

D	B	d	Z	V	Tmax.	n min - n max	Art. Nr.
160	4-7,5	30/50	8	4	32	4800-8300	4849.160.004
	4-15,0	30/50	8	4	32	4800-8300	4849.160.104
180	4-7,5	30/50	8	4	32	4300-7400	4849.180.004
	4-15,0	30/58	8	4	32	4300-7400	4849.180.104

- Inklusive Zwischenring-Satz
- Spacerset included

Wendemesser/Ersatzteile
Reversible knife/Spare parts

	Dim.	B	Art. Nr.
Wendemesser - Reversible knife	7,5x12x1,5	7,5 (4-15)	750.097
Spannkeil - Clamping wedge		7,5 (4-15)	707.002.07
Gewindestift - Screw	M5x12	7,5 (4-15)	705.523
Wendemesser - Reversible knife	18x18x1,95	4-7,5	766.101
Ring - Nut	11,9x1,7	4-7,5	709.129
Vorschneider - Spur	14x14x1,2	4-7,5	750.113
Ring - Nut	9,9x1,6	4-7,5	709.128
Spannschraube - Screw	M4x3,2	4-7,5	705.313
Sechskantschlüssel - T Wrench	SW2,5 (M5)		706.102
Torx Schlüssel - Torx wrench	T9		706.301
Zwischenringsatz - Spacers set		4-7,5	703.032

5949

HW Verstellnutter mit Vorschneiden auf Gewindebüchse - Wendemesser
TC Adjustable grooving cutter with threaded bushing - Reversible knife

PG
02

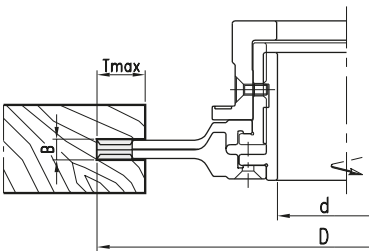
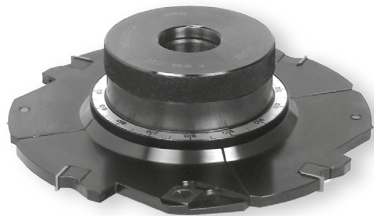

WP-Nutfräsersatz für Handvorschub, stufenlos einstellbar
Grooving cutterset for manual feed with reversible knives, continuously adjustable

MAN

HW

D	B	d	Z	V	Tmax.	n min - n max	Art. Nr.
180	8-15	30/50	4	4	32	4300-7400	5949.180.008
	12,6-24	30/50	4	4	32	4300-7400	5949.180.013

Wendemesser/Ersatzteile
Reversible knife/Spare parts

	Dim.	B	Art. Nr.
Wendemesser - Reversible knife	7,5x12x1,5	8-15	750.097
	12x12x1,5	12,6-24	754.102
Spannkeil - Clamping wedge		8-15	707.002.06
Spannschraube - Screw	M5x16	8-15	705.582
	M8x16	12,6-24	705.542
Vorschneider - Spur	14x14x2		750.111
Spannschraube - Screw	M5x6	8-15	705.424
	M5x7	12	705.425
Sechskantschlüssel - T Wrench	SW2,5 (M5)		706.102
	SW (M8)		706.104
Einstell-Lehre - Gauge		0,3/0,8	717.309

4949

HW Verstellnutter mit Vorschneidern auf Gewindebühse - Wendemesser
TC Adjustable grooving cutter with threaded bushing - Reversible knife

PG
02



WP-Nufräsersatz für Handvorschub, stufenlos einstellbar
Grooving cutterset for manual feed with reversible knives, continuously adjustable

MAN

HW

D	B	d	Z	V	Tmax.	n min - n max	Art. Nr.
180	4-7,5	30/50	8	4	32	4300-7400	4949.180.004

Wendemesser/Ersatzteile
Reversible knife/Spare parts

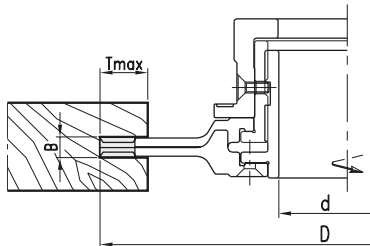

	Dim.	Art. Nr.
Wendemesser - <i>Reversible knife</i>	18x18x1,95	766.101
Ring - <i>Nut</i>	11,9x1,7	709.129
Vorschneider - <i>Spur</i>	14x14x1,2	750.113
Ring - <i>Nut</i>	9,9x1,6	709.128
Spannschraube - <i>Screw</i>	M4x3,2	705.313
Torx Schlüssel - <i>Torx wrench</i>	T9	706.301

8949

HW Verstellnutter mit Vorschneidern auf Gewindebühse - Festbestückt
TC Adjustable grooving cutter with spurs and threaded bushing - Tipped

PG
02



HW-bestückter Nufräsersatz mit Vorschneidern für Handvorschub, stufenlos einstellbar.
TC-tipped grooving cutterset with spurs for manual feed, continuously adjustable

MAN

HW

D	B	d	Z	V	Tmax.	n min - n max	Art. Nr.
150	4-7,5	30/50	4	4	27	5200-8900	8949.150.004
	7-13,5	30/50	4	4	27	5200-8900	8949.150.007
	10-19,5	30/50	4	4	27	5200-8900	8949.150.010

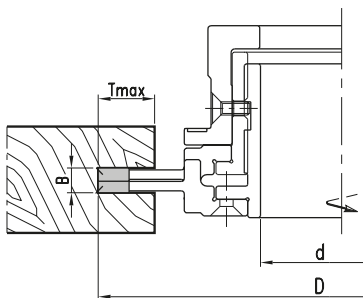

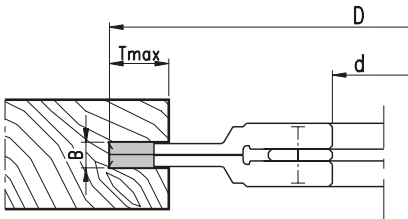

HW-bestückter Nutfräsersatz mit Vorschneidern für Handvorschub
TC-tipped grooving cutterset with spurs for manual feed
MAN
HW

D	B	d	Z	V	Tmax.	n min - n max	Art. Nr.
120	3,5-3,6	30/50	4	4	16	6400-11100	8849.120.004
	4-7,5	30/50	4	4	16	6400-11100	8849.120.104
	5-9,5	30/50	4	4	16	6400-11100	8849.120.005
	7-13,5	30/50	4	4	16	6400-11100	8849.120.007
	10-19,5	30/50	4	4	16	6400-11100	8849.120.010
140	4-7,5	30/50	4	4	22	5500-9500	8849.140.004
	5-9,5	30/50	4	4	22	5500-9500	8849.140.005
	7-13,5	30/50	4	4	22	5500-9500	8849.140.007
	10-19,5	30/50	4	4	22	5500-9500	8849.140.010
	15-29,5	30/50	4	4	22	5500-9500	8849.140.015
150	20-29,5	30/50	4	4	22	5500-9500	8849.140.020
	30-59,5	30/50	4	4	22	5500-9500	8849.140.030
	4-7,5	30/50	4	4	27	5200-8900	8849.150.004
	5-9,5	30/50	4	4	27	5200-8900	8849.150.005
	7-13,5	30/50	4	4	27	5200-8900	8849.150.007
160	10-19,5	30/50	4	4	27	5200-8900	8849.150.010
	4-7,5	30/50	4	4	32	4800-8300	8849.160.004
	5-9,5	30/50	4	4	32	4800-8300	8849.160.005
	7-13,5	30/50	4	4	32	4800-8300	8849.160.007
	10-19,5	30/50	4	4	32	4800-8300	8849.160.010

- Inklusive Zwischenring-Satz
- *Spacerset included*

Zwischenringsatz
Spacer set

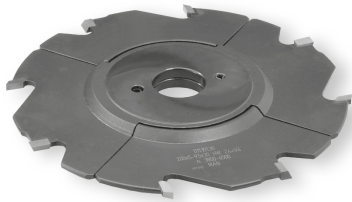
B	d	Art. Nr.
3,5-6,5	30/50	703.031
4-7,5	30/50	703.032
5-9,5	30/50	703.033
7-13,5	30/50	703.034
10-19,5	30/50	703.035
20-39,5	30/50	703.037
30-59,5	30/50	703.038

8879
HW Verstellnuter mit Vorschneidern - Festbestückt
TC Adjustable grooving cutter with spurs - Tipped
PG
02

HW-bestückter Nutfräsersatz mit Vorschneidern für Handvorschub
TC-tipped grooving cutterset with spurs for manual feed
MAN**HW**

D	B	d	Z	V	Tmax.	n min - n max	Art. Nr.
200	5-9,5	30/50	4	4	45	3900-6600	8879.200.005
	7-13,5	30/50	4	4	45	3900-6600	8879.200.007
	10-19,5	30/50	4	4	45	3900-6600	8879.200.010
250	7-13,5	30/50	4	4	70	3100-5300	8879.250.007
	10-19,5	30/50	4	4	70	3100-5300	8879.250.010
	15-29,5	30/50	4	4	70	3100-5300	8879.250.015

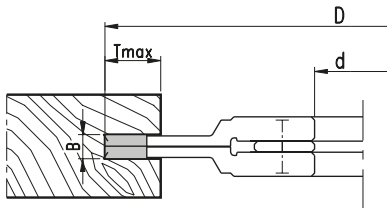
- Inklusive Zwischenring-Satz
- *Spacerset included*

Zwischenringsatz
Spacer set

B	d	Art. Nr.
5-9,5	30/50	703.033
7-13,5	30/50	703.034
10-19,5	30/50	703.035
15-29,5	30/50	703.036

8889
HW Verstellnuter mit Vorschneidern - Festbestückt
TC Adjustable grooving cutter with spurs - Tipped
PG
02

HW-bestückter Nutfräsersatz mit Vorschneidern für Handvorschub
TC-tipped grooving cutterset with spurs for manual feed
MAN**HW**

D	B	d	Z	V	Tmax.	n min - n max	Art. Nr.
250	7-13,5	30	8	8	40	3100-5300	8889.250.007
	10-19,5	30	8	8	40	3100-5300	8889.250.010
	15-29,5	30	8	8	40	3100-5300	8889.250.015

- Inklusive Zwischenring-Satz
- *Spacerset included*

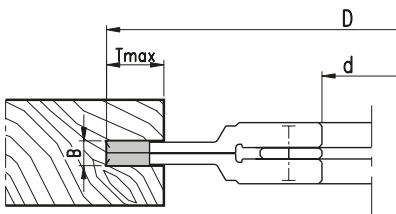

Zwischenringsatz
Spacer set

B	Art. Nr.
7-13,5	703.034
10-19,5	703.035
15-29,5	703.036

5749

HW Verstellnutter mit Vorschneidern - Festbestückt
TC Adjustable grooving cutter with spurs - Tipped

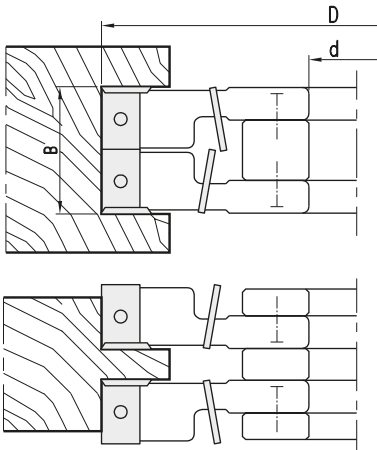
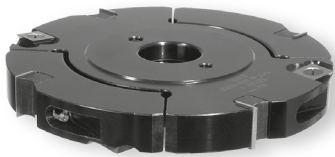
PG
02



WP-Nut- und Zapfenfräsersatz mit Vorschneidern für Handvorschub
TC-grooving and tenoning cutterset with reversible knives and spurs for manual feed

MAN

HW

D	B	d	Z	V	n min - n max	Art. Nr.
160	16-30	30/50	4	4	4800-8300	5749.160.016
	21-40	30/50	4	4	4800-8300	5749.160.021
	31-60	30/50	4	4	4800-8300	5749.160.031
	51-100	30/50	4	4	4800-8300	5749.160.051

- Inklusive Zwischenring-Satz
- Mit wechselseitigen Achswinkel
- *Spacer set included*
- *With alternating shear angle*

Wendemesser/Ersatzteile
Reversible knife/Spare parts

	Dim.	B	Art. Nr.
Wendemesser - <i>Reversible knife</i>	15x12x1,5	16-30	750.101
	20x12x1,5	21-40	750.102
	30x12x1,5	31-60	750.104
	50x12x1,5	51-100	750.106
Spannkeil - <i>Clamping wedge</i>		16-30	707.002.13
		21-40	707.002.18
		31-60	707.002.28
		51-100	707.002.48
Gewindestift - <i>Screw</i>	M8x16		705.542
Vorschneider - <i>Spur</i>	14x14x2		750.111
Spannschraube - <i>Screw</i>	M5x7		705.425
Sechskantschlüssel - <i>T wrench</i>	SW4		706.104
Zwischenringsatz - <i>Spacer set</i>		16-30	703.036
		21-40	703.037
		31-60	703.038
		51-100	703.042
Einstell-Lehre - <i>Gauge</i>		0,3/0,8	717.309

8749

HW Verstellnutter und Zapfenschneider - Festbestückt
TC Adjustable grooving- rebating cutter - Tipped

PG
02

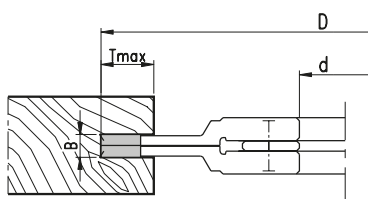

HW-bestückter Nut- und Zapfenfräsersatz mit Vorschneidern für Handvorschub
Tc-tipped grooving an tenoning cutterset with spurs for manual feed

MAN

HW

D	B	d	Z	V	Tmax.	n min - n max	Art. Nr.
150	20-39,5	30/50	6	6	35	5200-8900	8749.150.020
	30-59,5	30/50	6	6	35	5200-8900	8749.150.030

- Inklusive Zwischenring-Satz
- Mit wechselseitigen Achswinkel
- *Spacer set included*
- *With alternating shear angle*

Zwischenringsatz
Spacer set

B	d	Art. Nr.
5-9,5	30/50	703.033
7-13,5	30/50	703.034

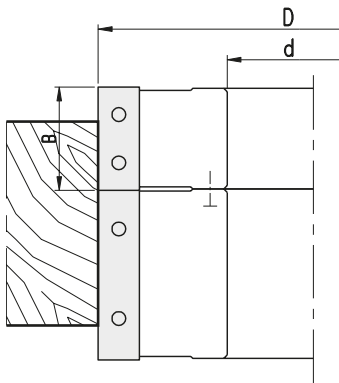

- Lösbarer Mitnahmestift
• Pin can be removed for individual use

WP-Fügefräser für Handvorschub

TC-Jointing cutter with reversible knives for manual feed

MAN

HW

D	B	d	Z	n min - n max	Art. Nr.
80	50	45	4	9600-16000	5109.080.050
100	30	30/35	4	7800-13300	5109.100.030
	50	30/35	4	7800-13300	5109.100.050
125	30	35/40/50	4	6200-10600	5109.125.030
	50	35/40/50	4	6200-10600	5109.125.050
	50	35/40	4	6200-10600	5109.125.150
	60	40/50	4	6200-10600	5109.125.060
	80	40/50	4	6200-10600	5109.125.080

- Kombination von Einsatzfräsern zur gewünschten Hobelbreite möglich.
- Combination of several single tools to the thickness of the wood to be jointed.

Wendemesser/Ersatzteile

Reversible knife/Spare parts

	Dim.	B	Art. Nr.
Wendemesser - Reversible knife	30x12x1,5	30	750.104
	50x12x1,5	50	750.106
	60x12x1,5	60	750.107
	80x13x2,2	80	750.108
Spannkeil - Clamping wedge		30	707.002.28
		50 (D80)	707.001.48
		50	707.002.48
		60	707.002.58
		80	707.002.78
Gewindestift - Screw	M6x12 (D80)		705.553
	M8x16		705.542
Sechskantschlüssel - T Wrench	SW3 (M6)		706.103
	SW4 (M8)		706.104
Einstell-Lehre - Gauge		1,0	717.302

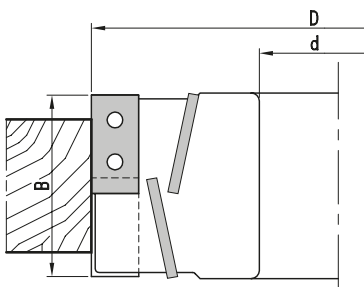
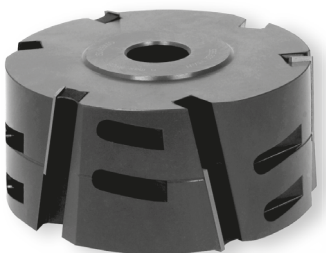

WP-Fügefräser für Handvorschub mit wechselseitigem Achswinkel.

TC-Jointing cutter with alternating shear angle.

MAN

HW

D	B	d	Z	n min - n max	Art. Nr.
100	56	30 DKN	3+3	7800-13300	5709.100.056
125	56	30/40 DKN	3+3	6200-10600	5709.125.056
150	56	30/40 DKN	3+3	5200-8900	5709.150.056
180	56	30/40 DKN	3+3	4300-7400	5709.180.056

- Mit beidseitigem ziehendem Schnitt.
- With alternating axial angle

Wendemesser/Ersatzteile

Reversible knife/Spare parts

	Dim.	B	Art. Nr.
Wendemesser - Reversible knife	30x12x1,5	30	752.102
Spannkeil - Clamping wedge	RH		707.133.28
	LH		707.130.28
Gewindestift - Screw	M8x16		705.542
Sechskantschlüssel - T Wrench	SW4		706.104
Einstell-Lehre - Gauge		1,0	717.302

5904

HW Füge-Hobelfräser-Aufbausystem - Wendemesser
 TC Planning cutterhead-constructions system - Reversible knife

PG
02

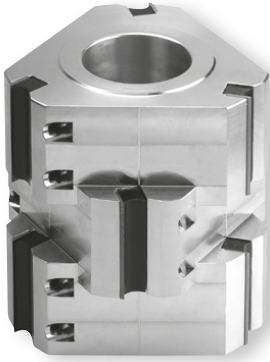

WP-Fügefräser für mechanischen Vorschub
 TC-Jointing cutter reversible knives for mechanical feed

MEC

HW

D	B	d	Z	n max	Art. Nr.
125	130	40	3(9)	10200	* 5904.125.050
	230	40	3(15)	10200	* 5904.125.030

- * Ausführung mit Leichtmetall-Grundkörper
 * Light alloy body
- Kombination von Einzelfräsern zur gewünschten Hobelbreite möglich.
 • Combination of several single tools to the thickness of the wood to be jointed.

Wendemesser/Ersatzteile
 Reversible knife/Spare parts

	Dim.	Art. Nr.
Wendemesser - Reversible knife	50x12x1,5	755.105
Spannkeil - Clamping wedge		707.002.48
Gewindestift - Screw	M8x16	705.542
Sechskantschlüssel - T Wrench	SW4	706.104
Einstell-Lehre - Gauge	1,0	717.302

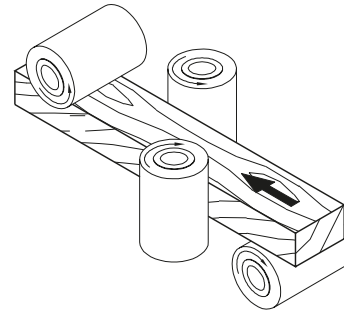
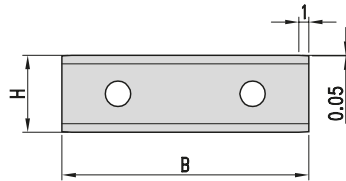
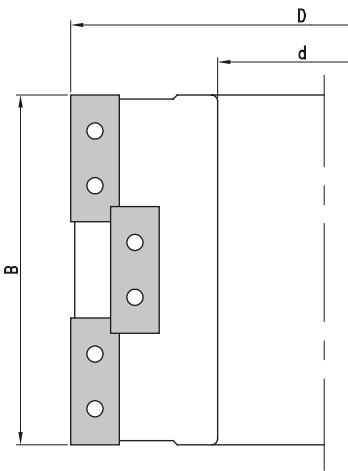

8709

HW Füge-Hobelkopf - Festbestückt
 TC Jointing cutter - Tipped

PG
02



HW-Fügefräser für Handvorschub. Mit beidseitig ziehendem Schnitt.
 TC-Jointing cutter, tipped, for manual feed. With alternating axial angle.

MAN

HW

D	B	d	Z	n min - n max	Art. Nr.
140	20	30/50	4	5500-9500	8709.140.020
	30	30/50	4	5500-9500	8709.140.030
	40	30/50	4	5500-9500	8709.140.040
	50	30/50	4	5500-9500	8709.140.050

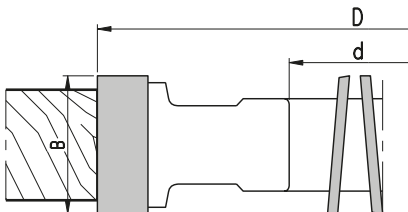

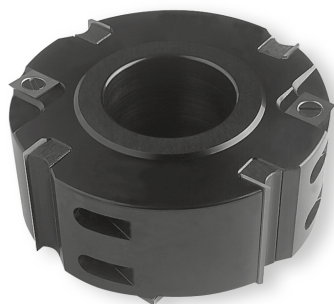

WP-Falzmesserkopf, Geradeverzahnf. Zum Fügen, Falzen und Nuten.
Tc-Rebating cutter, straight cut. For jointing, rebating and grooving.

MAN

HW

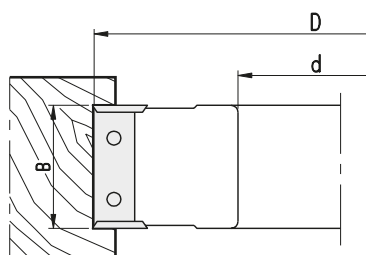
D	B	d	Z	V	n min - n max	Art. Nr.
100	50	30	2	4	7800-13300	5169.100.050
	50	30	4	4	7800-13300	5169.100.150
125	30	30/50	2	4	6200-10600	5169.125.030
	30	30/50	4	4	6200-10600	5169.125.130
	50	30/50	2	4	6200-10600	5169.125.050
	50	30/50	4	4	6200-10600	5169.125.150
	60	30/50	2	4	6200-10600	5169.125.060

Wendemesser/Ersatzteile
Reversible knife/Spare parts

	Dim.	B	Art. Nr.
Wendemesser - Reversible knife	30x12x1,5	30	750.104
	50x12x1,5	50	750.106
	60x12x1,5	60	750.107
Spannkeil - Clamping wedge		30	707.002.28
		50	707.002.48
		60	707.002.58
Gewindestift - Screw	M8x16		705.542
Vorschneider - Spur	14x14x2		750.111
Spannschraube - Screw	M5x7		705.425
Sechskantschlüssel - T Wrench			706.104
Einstell-Lehre - Gauge			717.302

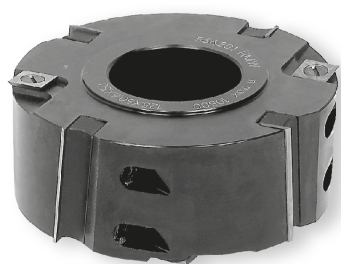

WP-Falzmesserkopf mit wechselseitigem Achswinkel. Zum Fügen, Falzen und Nuten.
Tc-Rebating cutter with reversible knives. For jointing, rebating and grooving.

MAN

HW

D	B	d	Z	V	n min - n max	Art. Nr.
125	50	30/50	4	4	6200-10600	5769.125.050
140	50	30/50	4	4	5500-9500	5769.140.050
147	50	40	4	4	5200-9000	5769.147.050

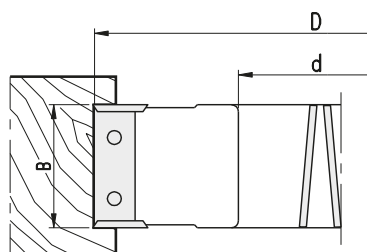
- Mit beidseitig ziehendem Schnitt.
- With alternating axial angle.

Wendemesser/Ersatzteile
Reversible knife/Spare parts

	Dim.	B	Art. Nr.
Wendemesser - Reversible knife	50x12x1,5		750.106
Spannkeil - Clamping wedge	RH		707.133.48
	LH		707.130.48
Gewindestift - Screw	M8x16		705.542
Vorschneider - Spur	14x14x2		750.111
Spannschraube - Screw	M5x7		705.425
Sechskantschlüssel - T Wrench	SW4		706.104
Einstell-Lehre - Gauge		0,3x0,8	717.309

8769

HW Falzfräser mit Vorschneidern - Festbestückt
TC Rebating cutter - Tipped

PG
02



HW-Falzmesserkopf mit wechselseitigem Achswinkel. Zum Fügen, Falzen und Nuten.
TC-tipped Rebating cutter, with alternating axial angle. For jointing, rebating and grooving.

MAN

HW

D	B	d	Z	V	n min - n max	Art. Nr.
140	30	30/50	4	4	5500-9500	8769.140.030
	40	30/50	4	4	5500-9500	8769.140.040
	50	30/50	4	4	5500-9500	8769.140.050

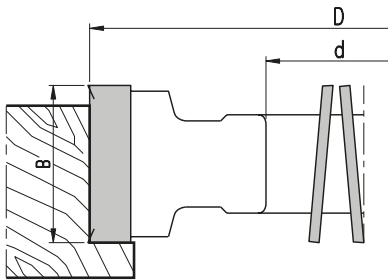

5160

HW Führunfalzfräser mit Vorschneidern - Wendemesser
TC Guiding cutter - Reversible knife

PG
02

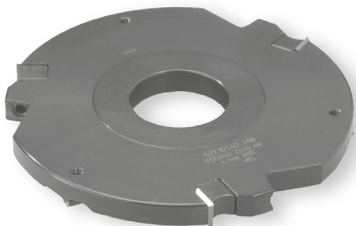

WP-Falzmesserkopf, Geradeverzahn. Zum Fügen, Falzen und Nuten.
Tc-Rebating cutter, straight cut. For jointing, rebating and grooving.

MEC

HW

Nr.	D	B	d	Z	V	n max	Art. Nr.
1	145	12	40	3	3	11000	5160.145.003
2	145	12	40	2	2	11000	5160.145.002
1	160	18	40	3	3	9000	5160.160.050

- Ausführung für WP-Spiralmesserkopf D140
- Type for helicoidal planing cutterhead D140

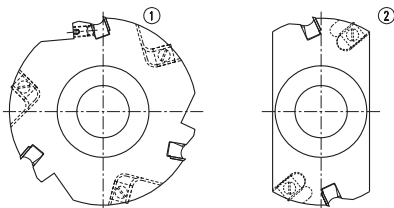

Wendemesser/Ersatzteile
Reversible knife/Spare parts

	Dim.	B	Art. Nr.
Wendemesser - Reversible knife	12x12x1,5	12	754.102
	17,6x12x1,5	18	750.205
Spannkeil - Clamping wedge		12	707.002.10
Gewindestift - Screw	M8x16		705.542
Vorschneider - Spur	14x14x2		750.111
Spannschraube - Screw	M5x7		705.425
Sechskantschlüssel - T Wrench	SW4		706.104
Einstell-Lehre - Gauge		0,3x0,8	717.309

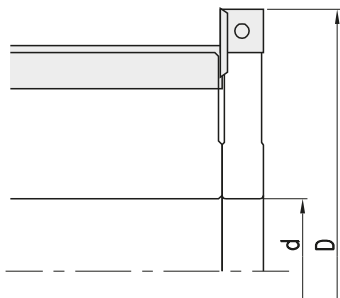

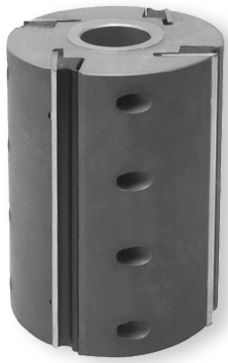

Auslieferung inkl. Hobelmesser
HS 18%. HW Messer auf Wunsch.

*Tipped with HS 18% knives.
TC knives on demand.*

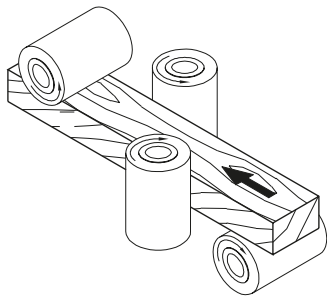
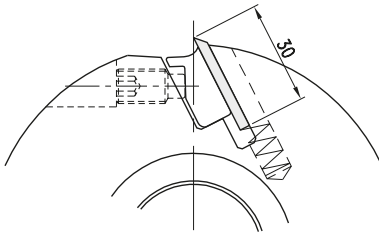
Hobelmesserkopf für Streifenhobelmesser.
Planing cutterhead for planer knives.
MAN HW/HS

D	B	d	Z	n max	Art. Nr.	Art. Nr.
125	80	40	4	9000	* 0104.125.080	0104.125.081
	100	40	4	9000	* 0104.125.100	0104.125.101
	120	40	4	9000	* 0104.125.120	0104.125.121
	130	40	4	9000	* 0104.125.130	0104.125.131
	150	40	4	9000	* 0104.125.150	0104.125.151
	180	40	4	9000	* 0104.125.180	0104.125.181
	220	40	4	9000	* 0104.125.220	0104.125.221
	230	40	4	9000	* 0104.125.230	0104.125.231
	240	40	4	9000	* 0104.125.240	0104.125.241

- * Ausführung mit Leichtmetall-Grundkörper
- * *Light alloy body*
- Klemmung mit Druckbackensystem.
- Messerpositionierung erfolgt über Druckfedern unter den Streifenhobelmessern und Positionierung über die Einstelllehre.
- *Knives clamped by wedges.*
- *Knife position through pressure springs that press the knives to the defined edge cutting circle with the setting gauge.*

Ersatzteile
Spare parts

	Dim.	B	Art. Nr.
Spannkeil - <i>Clamping wedge</i>		80	707.432
		100	707.433
		120	707.434
		130	707.435
		150	707.436
		180	707.437
		220	707.438
		230	707.439
Feder - <i>Spring</i>			709.122
Gewindestift - <i>Screw</i>	M10x20		705.552
Sechskantschlüssel - <i>Wrench</i>	SW5		706.105

Streifenhobelmesser
Knives

B	H	d	Art. Nr. HS	Art. Nr. HW
80	30	3	771.080.30	773.080.30
100	30	3	771.100.30	773.100.30
120	30	3	771.120.30	773.120.30
130	30	3	771.130.30	773.130.30
150	30	3	771.150.30	773.150.30
170	30	3	771.170.30	773.170.30
180	30	3	771.180.30	773.180.30
200	30	3	771.200.30	773.200.30
220	30	3	771.220.30	773.220.30
230	30	3	771.230.30	773.230.30

- * Ausführung mit Leichtmetall-Grundkörper
- * *Light alloy body*
- Klemmung mit Druckbackensystem.
- Messerpositionierung erfolgt über Druckfedern unter den Streifenhobelmessern und Positionierung über die Einstelllehre.
- *Knives clamped by wedges.*
- *Knife position through pressure springs that press the knives to the defined edge cutting circle with the setting gauge.*



WP-Messerkopf aus Leichtmetall
 Planing alu-cutterhead

MEC

HW

D	B	d	Spir.	n max	Art. Nr.
163	150	50	6	8000	* 5101.163.150
	180	50	6	8000	* 5101.163.180
	230	50	6	8000	* 5101.163.230
	260	50	6	8000	* 5101.163.260
	310	50	6	8000	* 5101.163.310
185	410	50	6	7000	* 5101.185.410
200	150	60	10	6500	* 5101.200.150
	180	60	10	6500	* 5101.200.180
	230	60	10	6500	* 5101.200.230
	260	60	10	6500	* 5101.200.260
	310	60	12	6500	* 5101.200.310
230	150	50	12	5700	* 5101.230.150

- * Ausführung mit Leichtmetall-Grundkörper
- * Light alloy body

- WP-Messerkopf mit 4-seitig schneidenden Wendepaletten und integriertem, offenem Hydro-Spannsystem für Fettpresse.
- Hydrosystem als Zentrier-Spannsystem bei Betriebsdruck von ca. 300-400bar (täglich kontrollieren).
- Gewendelte Hochleistungs-Ausführung
 Reduziert die Lesitungsaufnahme im Vergleich zu geradeverzahnten Hobelköpfen erheblich. Reduzierung des Hobelgeräusches auf ein Minimum. Herstellung glatter Hobelköpfe durch den Einsatz verrundeter Wendepaletten.
 Durch die geringere Lesitungsaufnahme besteht die Möglichkeit großer Spanabnahme im Bedarfsfall. Vielfach bewährter Einsatz auf Vorhobel- und Bauholz-Fertighobelwellen.
- Planing alu-cutterhead with 4x HW turnable knives and integrate, open hydroclamping system for greasepump. Hydrosystems as centering-clampingsystem for working pressure between 300 and 400 bar (check daily).
- Helicoidal high performance construction.
 Reduction of input power in comparison with straight teethed planing heads.
 Reduction of radiated noise. For production of plain planing areas through use of rounded turnable knives. In case of need possibility of big chip removal low quantity taken.
 Well proven application on preplaning and lumber planing spindles.

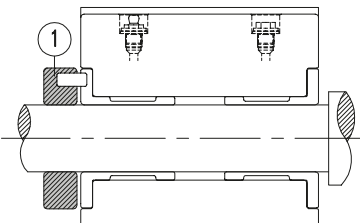
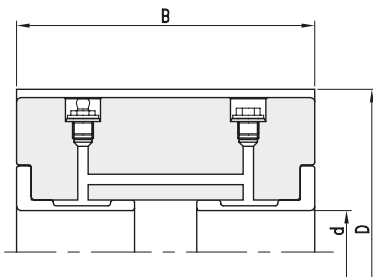

Zur Sicherung Spindelklemmring verwenden ①

You should always use the safety ring while setting up the cutter ①

Wendemesser/Ersatzteile
 Reversible knives/Spare parts

	Dim.	Art. Nr.
Wendemesser, ballig - Reversible knife rounded	15x15x2,5	754.106
Spannschraube - Screw	M5x13	705.320.13
Torx Schlüssel - Torx wrench	T20	706.305

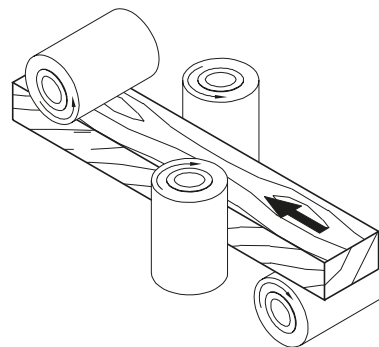
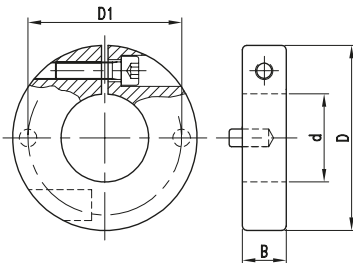



Schema gültig bis Z=12 ab Z=16
Schmiernippel stirnseitig!

*Schema valid until Z=12 from Z=16
grease nipples on the face side!*

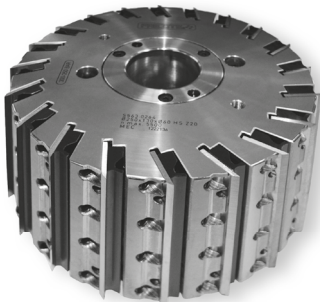
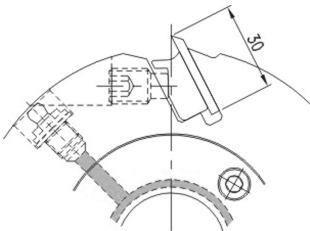
Hydro-Hobelmesserkopf - Streifenhobelmesser
Hydro planing cutterhead - Reversible knife

MEC

HS

D	B	d	Z	n max	Art. Nr.
143	60	40	4	9000	0101.143.060
	100	40	4	9000	0101.143.100
	130	40	4	9000	0101.143.130
	150	40	4	9000	0101.143.150
	180	40	4	9000	0101.143.180
	230	40	4	9000	0101.143.230
143	60	40	6	9000	0101.143.061
	100	40	6	9000	0101.143.101
	130	40	6	9000	0101.143.131
	150	40	6	9000	0101.143.151
	180	40	6	9000	0101.143.181
	230	40	6	9000	0101.143.231
163	60	50	4	8000	0101.163.060
	100	50	4	8000	0101.163.100
	130	50	4	8000	0101.163.130
	150	50	4	8000	0101.163.150
	180	50	4	8000	0101.163.180
	230	50	4	8000	0101.163.230
163	60	50	6	8000	0101.163.061
	100	50	6	8000	0101.163.101
	130	50	6	8000	0101.163.131
	150	50	6	8000	0101.163.151
	180	50	6	8000	0101.163.181
	230	50	6	8000	0101.163.231
163	60	50	8	8000	0101.163.062
	100	50	8	8000	0101.163.102
	130	50	8	8000	0101.163.132
	150	50	8	8000	0101.163.152
	180	50	8	8000	0101.163.182
	230	50	8	8000	0101.163.232
203	60	50	12	6000	0101.203.060
	80	50	12	6000	0101.203.080
	100	50	12	6000	0101.203.100
	130	50	12	6000	0101.203.130
	150	50	12	6000	0101.203.150
	180	50	12	6000	0101.203.180
	230	50	12	6000	0101.203.230
203	60	50	16	6000	0101.203.061
	80	50	16	6000	0101.203.081
	100	50	16	6000	0101.203.101
	130	50	16	6000	0101.203.131
	150	50	16	6000	0101.203.151
	180	50	16	6000	0101.203.181
	230	40	16	6000	0101.203.231

- Auslieferung inkl. Hobelmesser HS 18%
- Messerkopf aus Stahl mit offenem Hydrospannsystem.
Bestückung mit HS-Streifenhobelmessern beinhaltet. Hydrosystem als Zentrier-Spannsystem bei Betriebsdruck von ca. 300-400bar (täglich kontrollieren).
- *Cutterhead supplied with 18% HS knives.*
- *Planing steel-cutterhead with integrated, open hydroclamping system for greasepump.
HS-planer knives included. Hydrosystem as centering-clampingsystem for working pressure between 300 and 400bar (check daily).*

0101

HW/HS Hobelmesserkopf - Zuberhör, Ersatzteile

TC/HS Planing cutterhead - Attachments, spare parts

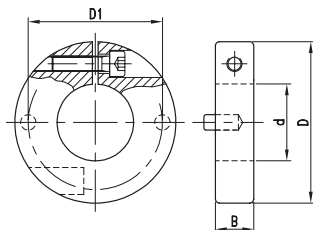
PG
02

Ersatzteile

Spare parts

	Dim.	B	Art. Nr.
Spannkeil - Clamping wedge		100	707.433
		120	707.434
		130	707.435
		150	707.436
		180	707.437
		220	707.438
Gewindestift - Screw	M12x20		705.556
	M10x20		705.552
Sechskantschlüssel - T Wrench	SW6		706.106
Fettpumpe - Grease pump			724.401
Fettkartusche - Grease cartridge			724.402
Klemmring - Safety ring			724.404

1104

HS Hobelkopf CentroLock - Wendemesser

HS Planing cutterhead CentroLock - Reversible knife

PG
02

HS Hobelkopf CentroLock

HS Planing cutterhead CentroLock

MEC

HS

D	B	d	Z	n max	Art. Nr.
125	80	40	4	10000	1104.125.080
100	40	40	4	10000	1104.125.100
130	40	40	4	10000	1104.125.130
150	40	40	4	10000	1104.125.150
180	40	40	4	10000	1104.125.180
230	40	40	4	10000	1104.125.230
240	40	40	4	10000	1104.125.240

- Auslieferung inkl. CentroLock HS-Messer
- Werkzeugsystem für CentroLock-Messer mit fliehkraftunterstützter, formschlüssiger Messerspannung. System lässt das Nachschärfen der CentroLock Messer zu. Nachschärfzone ca. 1mm je Seite. Exakte Durchmesserkonstanz nach jedem Schärfen.
- Wendehobelmesser in HS und HW unterschiedlicher Körnung verfügbar.
- Tool system for CentroLock form-fit knives clamping supported by centrifugal force. Resharpenable constant diameter tool. Diameter constant after resharpening.
- Turnable knives in HS or HW different gains available.

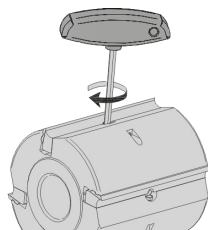

Klemmbalken lösen
Release the clamping wedge

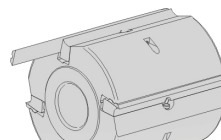

Messer wechseln
Change the knife

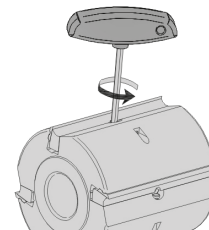

Klemmbalken spannen
Fix the clamping wedge

Ersatzteile

Spare parts

	Dim.	Art. Nr.
CentroLock HS Hobelmesser - CentroLock HS knife	80x16x3	776.080.016
	100x16x3	776.100.016
	130x16x3	776.130.016
	150x16x3	776.150.016
	180x16x3	776.180.016
	230x16x3	776.230.016

Herstellung auf Anfrage für verschiedene Hobelmaschinen und Messersysteme.
Wir bieten Hobelwellen für folgende Messersysteme an:

- Streifenhobelmesser
- Rückenverzahnte Hobelmesser
- Tersamesser
- CentroLock-Messer
- Wendemesser für spiralisierte Hobelwellen

*On demand for different types of planing- and milling-machines and knifetypes.
We offer knife driving shafts for this knife systems:*

- *Planing knives*
 - *Backserrated knives*
 - *Tersaknives*
 - *CentroLock-knives*
 - *Reversible knives for helicoidal driving shafts*
- **Bitte verwenden Sie für Ihr Anfrage die Dimensionszeichnung.**
 - *Please use for your inquiry the dimensions drawing.*

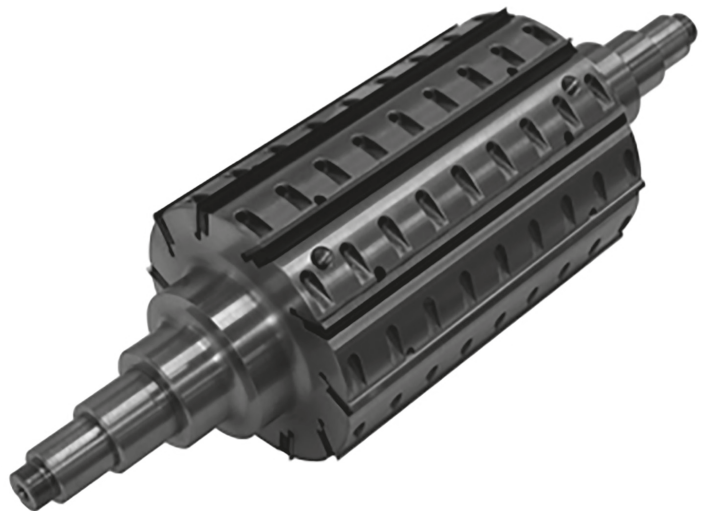
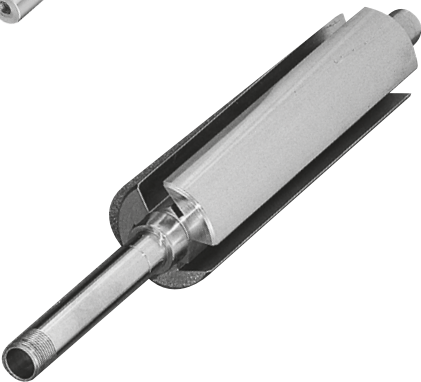
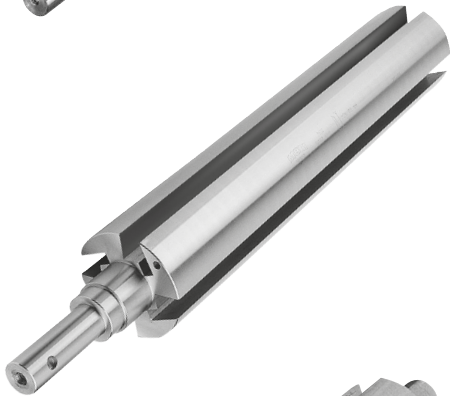
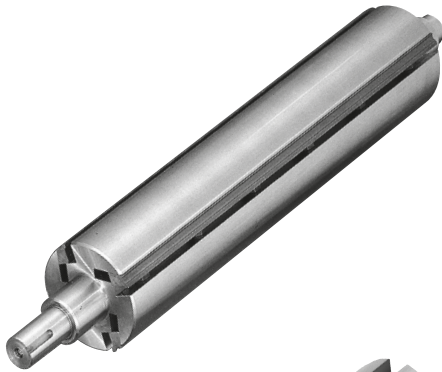

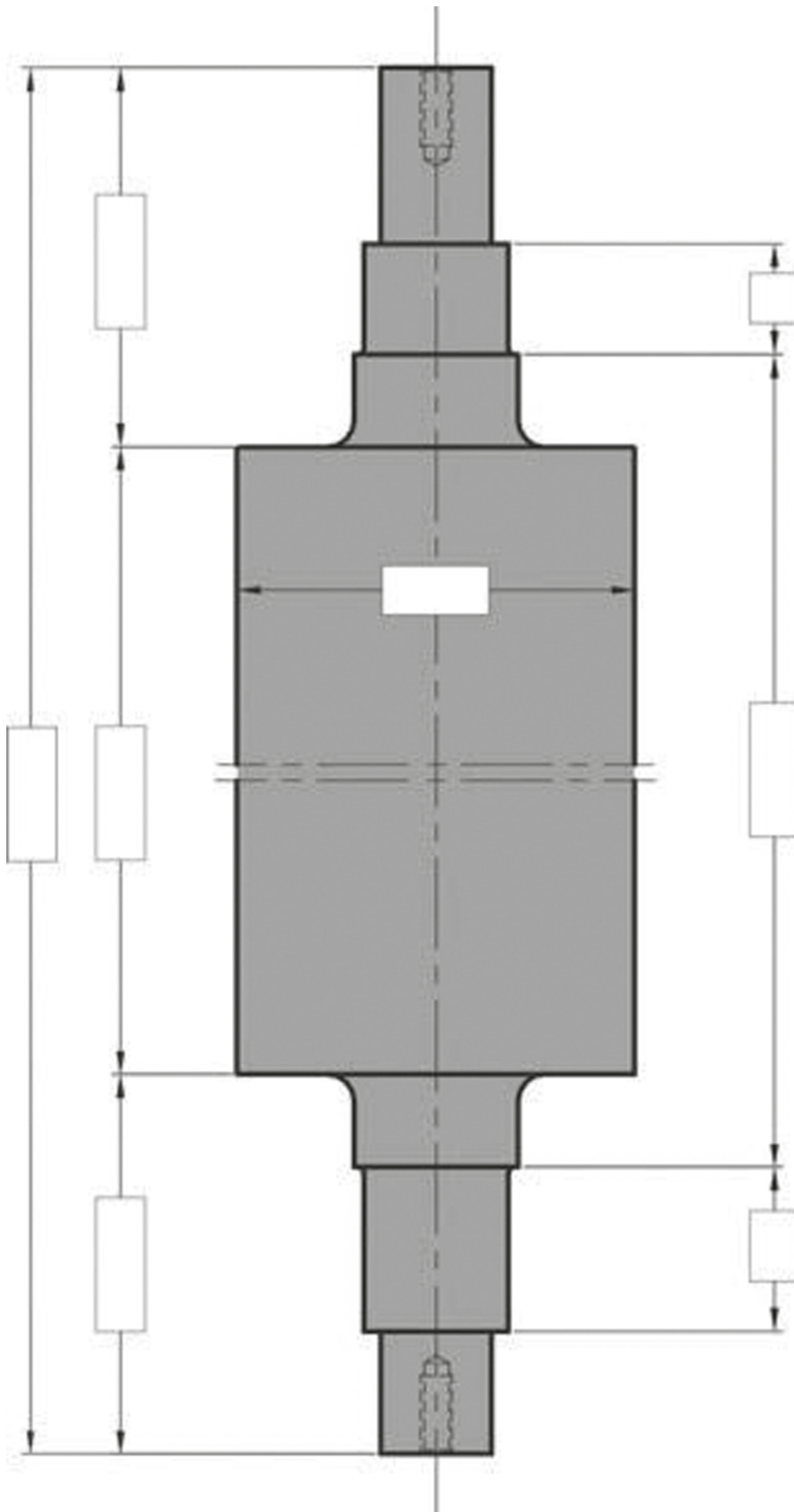

- Bitte tragen Sie die gewünschten Abmessungen ein.
Senden Sie uns eine Kopie mit Angabe des gewünschten Messersystems als Anfrage zu.
Als Messersysteme kommen in Frage:
Tersa, Centrollock, HW-Wendemesser 15x15x2,5 oder 21x21x5,5, Streifenhobelmesser, rückenverzehrte Hobelmesser.
- *Please fill in the needed dimensions.
Send us a copy with the information of wanted knife type.
We offer driving shafts for:
Tersa, Centrollock, TC-rev knives 15x15x2,5 or 21x21x5,5, planing knives, corrugated knives.*

HSK85WS-Hobelkopf Z=2
HSK85WS-Planing head Z=2
MEC**HS**

D	B	d	Z	n max	Art. Nr. LH	Art. Nr. RH
93	60	HSK85WS	2	12000	1402.093.060	1402.093.061
	80	HSK85WS	2	12000	1402.093.080	1402.093.081
	100	HSK85WS	2	12000	1402.093.100	1402.093.101
	130	HSK85WS	2	12000	1402.093.130	1402.093.131
	150	HSK85WS	2	12000	1402.093.150	1402.093.151
	170	HSK85WS	2	12000	1402.093.170	1402.093.171
	190	HSK85WS	2	12000	1402.093.190	1402.093.191
	210	HSK85WS	2	12000	1402.093.210	1402.093.211
	240	HSK85WS	2	12000	1402.093.240	1402.093.241

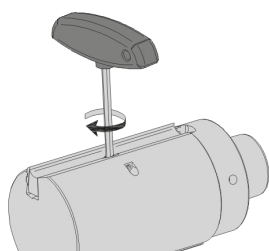
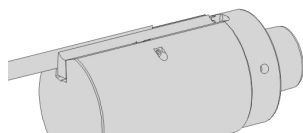
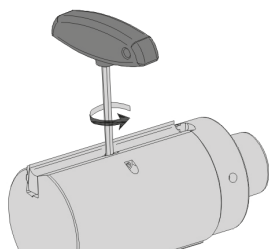
Klemmbalken lösen
Release the clamping wedge

Messer wechseln
Change the knife

Klemmbalken spannen
Fix the clamping wedge

- Hobelmesserkopf zum Einsatz auf Vierseiten-Hobel- und Profiliermaschine mit HSK85WS Schnittstelle. Bestückt mit HS CentroLock Wendemessern. Monoblock-Ausführung hoher Wuchtgüte für max. Drehzahl 12 000 U/min.
- Betrieb in Kombination mit Abrund bzw. Fasenfräser auf Anfrage
- Werkzeugsystem für CentroLock-Messer mit fliehkraftunterstützter, formschlüssiger Messerspannung. System lässt das Nachschärfen der CentroLock Messer zu, Nachschärfzone ca. 1mm je Seite. Exakte Durchmesserkonstanz nach jedem Schärfen. Wendehobelmesser in HS und HW unterschiedlicher Körnung verfügbar.
- *Planerhead for use on four-sided moulders with HSK85WS interface. Supplied with HS-CentroLock knives. Monobloc-design with high balance quality for max. 12 000 U/min.*
- *Use in combination with rounding- or bevelling-cutter on request.*
- *Tool system for CentroLock from-fit knives clamping supported by centrifugal force. Resharpenable constant diameter tool. Diameter constant after resharpening. Turnable knives in HS or HW different grains available.*

HSK85WS-Hobelkopf Z=4
HSK85WS-Planing head Z=4
MEC**HS**

D	B	d	Z	n max	Art. Nr. LH	Art. Nr. RH
93	60	HSK85WS	4	12000	1402.093.062	1402.093.063
	80	HSK85WS	4	12000	1402.093.082	1402.093.083
	100	HSK85WS	4	12000	1402.093.102	1402.093.103
	130	HSK85WS	4	12000	1402.093.132	1402.093.133
	150	HSK85WS	4	12000	1402.093.152	1402.093.153
	170	HSK85WS	4	12000	1402.093.172	1402.093.173
	190	HSK85WS	4	12000	1402.093.192	1402.093.193
	210	HSK85WS	4	12000	1402.093.212	1402.093.213
	240	HSK85WS	4	12000	1402.093.242	1402.093.243

Wir bieten 3 verschiedene HSK85WS-Werkzeug-Ausführungen an:

1. HSK85WS-Werkzeuge mit Monoblock-Tragkörper
2. HSK85WS-Werkzeuge mit unlösbar adaptiertem Hohlchaftkegel HSK85WS
3. Aufnahmedorne HSK85WS zum Spannen von Bohrungswerkzeugen.
Ermöglicht den Einsatz vorhandener Werkzeuge mit Bohrung auf PowerMat-Maschinen.

We offer 3 different HSK80WS-tooling types:

1. HSK85WS-tools with steel monobloc tool body.
2. HSK85WS-tools with non-detachably mounted hollow taper/shank HSK85WS.
3. Holding arbors HSK85WS for clamping tools with bore.
Allows existing tools with bore to be used on PowerMat-machines.



- Auf Wunsch fertigen wir HSK85WS-Hobelmesserköpfe mit rückenverzahnten Hobelmessern der Stärken 4mm - 8mm als Monoblock-Ausführung hoher Wuchtgüte.
- *On demand we produce HSK85WS-Planerheads with serrated back knives t = 4mm - 8mm in monobloc-design with high balance quality.*

HW Spiralmesserkopf
TC Helicoidal planing cutterhead

MEC

HW

D	B	d	Spiralen	Typ	n max	RH/oben	LH/unten	Art. Nr.
125	100	40	6 (30)	1	10000			5104.125.100
	130		6 (36)	1	10000			5104.125.130
	130		6 (36)	2	10000	*		5104.125.132
	130		6 (36)	2	10000		*	5104.125.133
	180		6 (48)	1	10000			5104.125.180
	230		6 (60)	1	10000			5104.125.230
	240		6 (63)	2	10000	*		5104.125.240
	240		6 (63)	2	10000		*	5104.125.241

- Ausführung mit Leichtmetall-Grundkörper
- 6 Spiralen, bestückt mit balligen WP 15x15x2,5

- *Light alloy body*
- *6 spirals, fitted with crowned WP 15x15x2.5*

Gewendelte Ausführung

Aufteilung der Spanabnahme. Führt zu reduzierter Antriebsleistung.
Minimiertes Arbeitsgeräusch.

Coiles layout

*Segmentation of chip removal. Leads to reduced input power.
Reduction of radiated noise.*

- WP-Messerkopf mit 4-seitig schneidenden Wendepplatten. Glatte Oberflächen durch bombierte Schneidkanten. Kaum sichtbare Markierungen im Überschneidungsbereich, dennoch für fertig gehobelte Oberflächen nur bedingt geeignet. Anordnung der Wendepplatten standardmäßig mit achsparalleler Schneidkante (Typ 1). Typ 2 mit in die Spirale eingedrehten Schneidkanten.
- *Planing alu-cutterhead with 4x HW turnable knives. Smooth surfaces from radiused cutting edges. Barely visible marks in the overlap area, minimal waviness, though limited suitability for producing finished surfaces. Arrangement of rev. knives as Type 1 with axially parallel cutting edge. Type 2 tools with cutting edge turned into spiral angle.*

Wendemesser/Ersatzteile
Reversible knives/Spare parts

	Dim.	Art. Nr.
Wendemesser, ballig - <i>Reversible knife rounded</i>	15x15x2,5	754.106
Spannschraube - <i>Screw</i>	M5x13	705.320.13
Torx Schlüssel - <i>Torx wrench</i>	T20	706.305

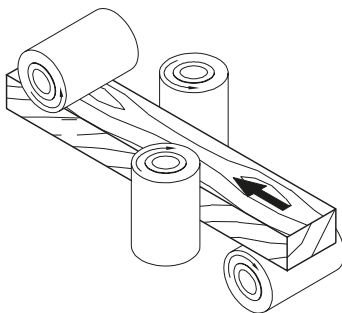

Typ 1



Typ 2

Festbestückter HW-Hobelkopf mit spiralig angeordneten Schneiden.
Tipped TC-cutterhead with helicoidal located knives
MAN
HW

D	B	d	Spiralen	n max	Art. Nr.
80	100	50	6 (30)	9500-15000	5209.080.100

- WP-Messerkopf mit 4-seitig schneidenden Wendeplatten. Glatte Oberflächen durch bombierte Schneidkanten. Kaum sichtbare Markierungen im Überschneidungsbereich, dennoch für fertig gehobelte Oberflächen nur bedingt geeignet.
- *Planing alu-cutterhead with 4x HW turnblade knives. Smooth surfaces from radiused cutting edges. Barely visible marks in the overlap area, minimal waviness, though limited suitability for producing finished surfaces.*

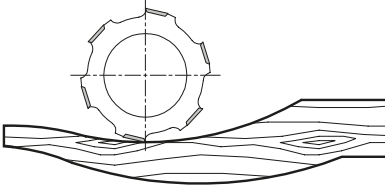

Wendemesser/Ersatzteile
Reversible knives/Spare parts

	Dim.	Art. Nr.
Wendemesser - <i>Reversible knife</i>	14x14x2	750.111
Spannschraube - <i>Screw</i>	M5x7	705.425
Torx Schlüssel - <i>Torx wrench</i>	T20	706.305

8104

HW Spiralfräser - Festbestückt

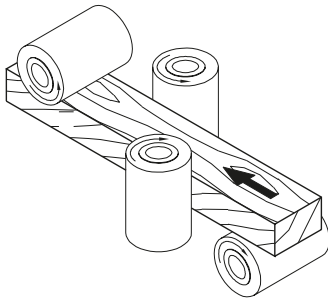
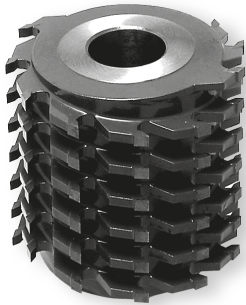
TC Helicoidal planing cutterhead - Tipped

PG
02

Festbestückter HW-Hobelkopf mit spiralig angeordneten Schneiden.
Tipped TC-cutterhead with helicoidal located knives

MEC

HW

D	B	d	Z	n max	Art. Nr.
125	120	40	12	12000	8104.125.120
	180	40	12	12000	8104.125.180
	230	40	12	12000	8104.125.230
140	120	40	12	10500	8104.140.120
	180	40	12	12000	8104.140.180
	230	40	12	12000	8104.140.230

- Glatte Oberflächen durch exakt eingeschliffenen Flugkreis.
- Auch für fertig gehobelte Oberflächen geeignet.

- *Smooth surfaces through exactly grinded cutting diameter.*
- *Also suitable for producing finished surfaces.*

Gewendelte Ausführung
Aufteilung der Spanabnahme.
Führt zu reduzierter Antriebsleistung.
Minimiertes Arbeitsgeräusch.

Coiled layout
Segmentation of chip removal.
Leads to reduced input power.
Reduction of radiated noise.

8109

HW Spiralfräser - Festbestückt

TC Helicoidal planing cutterhead - Tipped

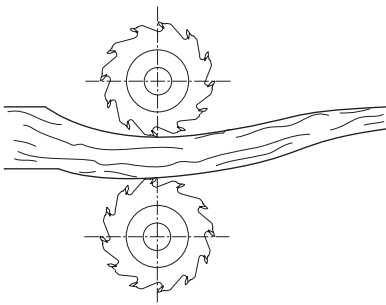
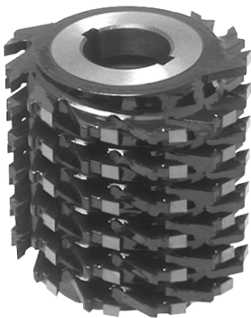
PG
02

Festbestückter HW-Hobelkopf mit spiralig angeordneten Schneiden.
Tipped TC-cutterhead with helicoidal located knives

MAN

HW

D	B	d	Z	n max	Art. Nr.
100	120	35	12	7800-13300	8109.100.120
	180	35	12	7800-13300	8109.100.180
120	180	35	12	6400-11100	8109.120.180

- Glatte Oberflächen durch exakt eingeschliffenen Flugkreis.
- Auch für fertig gehobelte Oberflächen geeignet.

- *Smooth surfaces through exactly grinded cutting diameter.*
- *Also suitable for producing finished surfaces.*

Gewendelte Ausführung
Aufteilung der Spanabnahme.
Führt zu reduzierter Antriebsleistung.
Minimiertes Arbeitsgeräusch.

Coiled layout
Segmentation of chip removal.
Leads to reduced input power.
Reduction of radiated noise.

01



Säge

02



Hobelmaschinen

03



Hobeln / Fräsen

04



Profilfräsen

05



Nub- und Federfräsen

06



Ob- und Unterfräsen

07



Bohren

08



PCD-Werkzeuge

09



Spannen

10



Ersatzteile

11

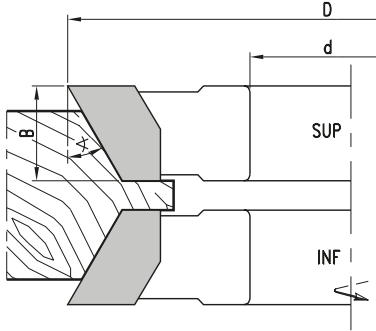
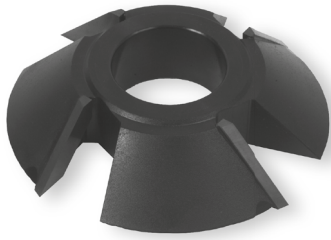

Informationen

8159**HW Fasefräser - Festbestückt**
*TC Beveling cutter - Tipped***PG
02****Festbestückter HW-Hobelkopf mit spiralig angeordneten Schneiden.**
*Tipped TC-cutterhead with helicoidal located knives***MAN****HW**

D	B	d	Z	α	n min.-n max	Art. Nr.	Art. Nr.
140	15	30/50	4	45°	5500-9500	8159.140.015	8159.140.115
150	30	30/50	4	45°	5200-8900	8159.150.030	8159.150.130
180	40	30/50	4	45°	4300-7400	8159.180.040	8159.180.140

- Festbestückter HW-Hobelkopf mit spiralig angeordneten Schneiden. Glatte Oberflächen durch exakt eingeschliffenen Flugkreis. Auch für fertig gehobelte Oberflächen geeignet.
- *Tipped TC-cutterhead with helicoidal located knives. Smooth surfaces through exactly grinded cutting diameter. Also suitable for producing finished surfaces.*

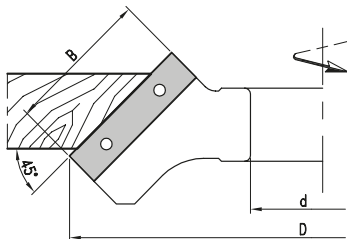
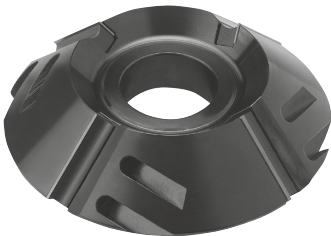
5159**HW Fasefräser - Wendemesser**
*TC Beveling cutter - Reversible knife***PG
02****WP-Fasefräser für Handvorschub***Tipped TC-beveling cutter reversible knives for manual feed***MAN****HW**

D	B	d	Z	n min.-n max	Art. Nr.
175	50	30/50	4	4300-7400	5159.175.050

Wendemesser/Ersatzteile*Reversible knives/Spare parts*

	Dim.	Art. Nr.
Wendemesser - <i>Reversible knife</i>	50x12x1,5	750.106
Spannkeil - <i>Clamping wedge</i>		707.002.48
Gewindestift - <i>Screw</i>	M8x16	705.542
Sechskantschlüssel - <i>T Wrench</i>	SW4	706.104

5119

HW Prismenfalzfräser - Wendemesser
TC Folding cutter - Reversible knife

PG
02

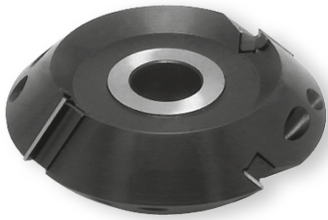

WP-Foldingfräser für Handvorschub.
TC-Foldingcutter with reversible knives.

MAN

HW

D	B	d	Z	W	T max	n min.-n max	Art. Nr.
140	42	30/50	2+2	90°	20	5500-9500	5119.140.030

- WP-Foldingfräser für Handvorschub. Zum Einfräsen von V-Nuten in Korpusteile, Schubladenelemente, Türzargen, etc. Der fräser Öffnungswinkel ist für eine 90°-Verbindung vorgesehen.
- *TC-Foldingcutter with reversible knives for manual feed. For cutting V-grooves in drawer elements, door, frames etc. The opening angle of the cutter is designed for 90°-connections.*

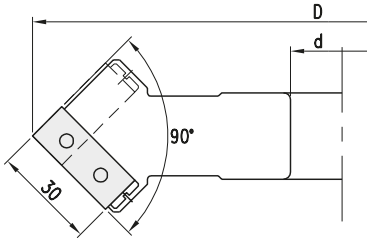

Wendemesser/Ersatzteile
Reversible knives/Spare parts

	Dim.	Art. Nr.
Wendemesser - Reversible knife	29,5x12x1,5	753.207
Spannkeil - Clamping wedge	LH	707.133.30
	RH	707.130.30
Gewindestift - Screw	M8x12	705.541
Sechskantschlüssel - T Wrench	SW4	706.104

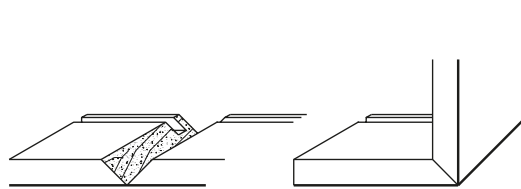

8119

HW Prismenfalzfräser - Festbestückt
TC Folding cutter - Tipped

PG
02

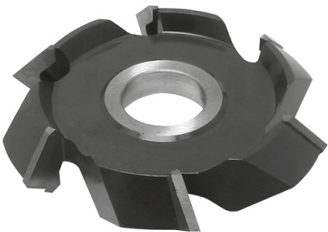

Festbestückter HW-Foldingfräser für Handvorschub.
Tipped TC-Foldingcutter for manual feed.

MAN

HW

D	B	d	Z	W	T max	n min.-n max	Art. Nr.
140	16	30/50	4	90°	7,0	5500-9500	8119.140.016
200	43	30	6	90°	21,0	3900-6600	8119.200.043
245	19	30	8	90°	8,0	3100-7000	*8119.245.019
245	19	30	8	135°	4,0	3100-7000	*8119.245.119

- Zum Einfräsen von V-Nuten in Korpusteile, Schubladenelemente, Türzargen, etc. Der Fräser Öffnungswinkel ist für eine 90°- bzw. 135°-Verbindung vorgesehen.
- *Tipped TC-Foldingcutter for manual feed. For cutting V-grooves in drawer elements, door, frames etc. The opening angle of the cutter is designed for 90°- or 135° connections.*

* Mit Flachfase 3mm für Alucobond
 * 3mm flat chamfered for Alucobond

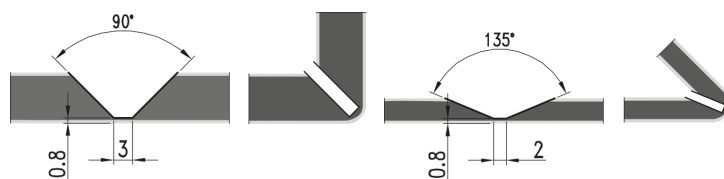
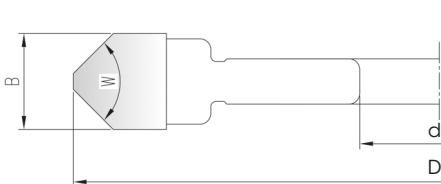
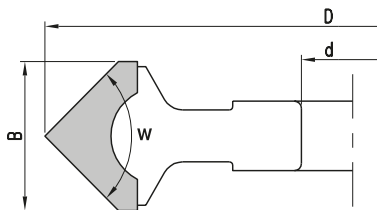



WP-Schwenkmesserkopf für Handvorschub.
Variangle bevel cutterhead for reversible knives.
MAN
HW

D	Dmax	B	d	Z	n min. -n max	Art. Nr.
140	163	50	30	2	5500-7500	5809.140.050
170	193	50	30/50	2	4500-6000	5809.170.050
	218	80	30/50	3	4500-6000	5809.170.080

- 120° stufenloser Verstellbereich. Präzises Einstellen vorgegebener Winkel über Winkel-Einstellehre.
- 120° continuously setting range. Exact positioning of an predetermined angle through setting gauge.

Wendemesser/Ersatzteile
Reversible knives/Spare parts

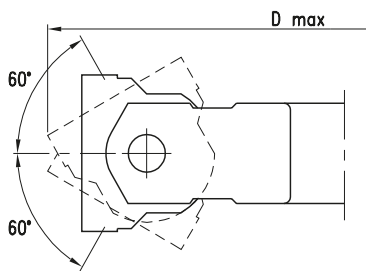
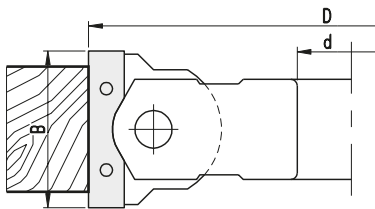
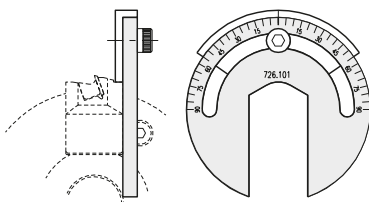
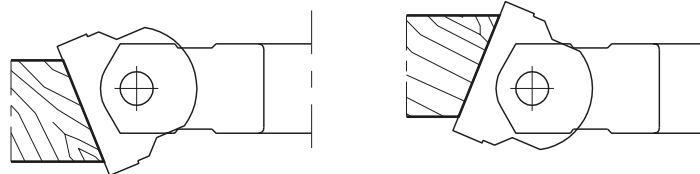
	Dim.	B	Art. Nr.
Wendemesser - Reversible knife	50x12x1,5		750.106
	80x13x2,2		750.108
Spannkeil - Clamping wedge		50	707.121
		80	707.128
Spannschraube - Screw	M8x10		705.540
Sechskantschlüssel - T Wrench	SW4		706.104
	SW5		706.105
Winkel-Einstell-Lehre - Setting gauge			726.101

 Stufenlos schwenkbar, Skala mit 2,5°-Teilung
Adjustable knife seating scale with 2,5° pitch

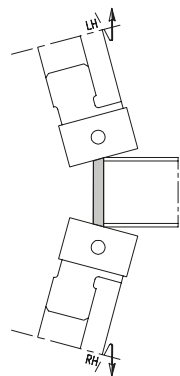
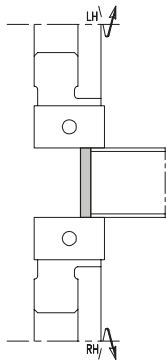
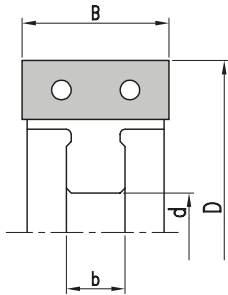
 Art. 726.101 · Winkel-Einstell-Lehre mit 1°-Teilung
 · Gauge with pitch 1°



WP-Fügefräser zum Bündigfräsen oder Anfasen von Kantenanleimern.
TC-Cutter with reversible knives for trimming or bevelling of edge bandings.
MEC**HW**

D	B/b	d	DKN	Z	n max	Art. Nr.
IMA						
50	15/10	16	5x2,3	2	18000	5108.050.015
Brandt - Homag - IDM - Stefani						
70	12/10	16	5x2,3	4	18000	5108.070.012
	12/10	16	5x2,3	6	18000	5108.070.112
SCM - Stefani						
70	20/11	16	6x3,5	6	18000	5108.070.420
	15/10	16	6x3,5	4	18000	5108.070.015
72	20/11	16	6x3,5	4	18000	5108.072.020
75	20/11	16	6x3,5	4	18000	5108.075.020
	30/11	16	6x3,5	4	18000	5108.072.030
80	20/11	16	5x2,3	4	18000	5108.080.020
	30/11	16	5x2,3	4	18000	5108.080.030
Ott						
70	20/10	16	5x2,3	4	18000	5108.070.020
Homag - IDM						
70	20/11	16	5x2,3	4	18000	5108.070.120
Olimpic - IDM - Homag						
70	20/10	16	6x3,5	6	18000	5108.070.220
Olimpic						
70	30/12	16	6x3,5	4	18000	5108.070.030
Holz-Her - Homag - IMA						
70	20/11	20	6x3,5	4	18000	5108.070.320
Holz-Her						
80	40/25	30	8x3,3	4	18000	5108.080.040

- 120° stufenloser Verstellbereich. Präzises Einstellen vorgegebener Winkel über Winkel-Einstellehre.
- 120° continuously setting range. Exact positioning of a pretermined angle through setting gauge.

Wendemesser/Ersatzteile
Reversible knives/Spare parts

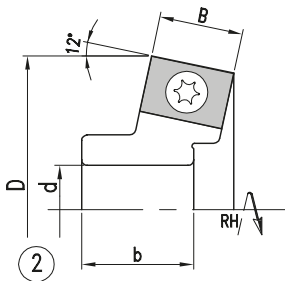
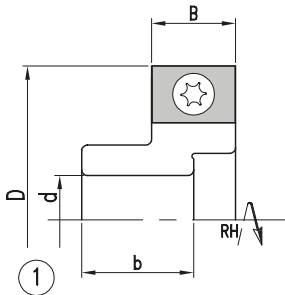
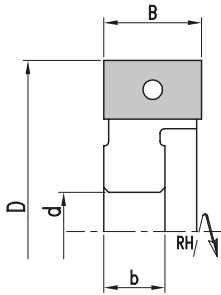
	Dim.	B	Art. Nr.
Wendemesser - Reversible knife	12x12x1,5		754.102
	15x12x1,5		750.101
	20x12x1,5		750.102
	30x12x1,5		750.104
	40x12x1,5		750.105
Spannkeil - Clamping wedge		12	707.001.10
		15	707.001.13
		20	707.001.18
		30	707.001.28
		40	707.001.38
Gewindestift - Screw	M6x12		705.533
Sechskantschlüssel - T Wrench	SW3		706.103
Einstell-Lehre - Gauge		1,0	717.302



Zum Bündigfräsen oder Anfasen von Kantenanleimern
For trimming or bevelling of edge bandings.

MEC**HW**

D	B/b	d	DKN	Z	n max	Art. Nr. LH	Art. Nr. RH
Brandt - Homag - IMA - IDM - SCM - Stefani							
70	20/12,5	20	6x3,5	4	18000	5284.070.220	5284.070.320
70	20/12,5	20	6x3,5	6	18000	5284.070.420	5284.070.520
SCM - Stefani							
72	30/12	16	6x3,5	4	18000	5284.072.030	5284.072.130
IDM							
70	30/10	16	5x2,3	4	18000	5284.070.030	5284.070.130
80	30/10	16	5x2,3	4	18000	5284.080.030	5784.080.130
Biesse							
70	16/19	16	5x2,3		18000	5284.070.016	5284.070.116
70	20/22	20	6x2,8		18000	5284.070.620	5284.070.720
80	20/22	20	6x2,8		18000	5284.080.020	5284.080.120
80	30/22	20	6x2,8		18000	5284.080.230	5284.080.330
SCM - Type 1							
48	14,6/20	16	5x2,3		18000	5284.048.015	5284.048.115
SCM - Type 2							
52,8	14,6/20	16	5x2,3		18000	5284.053.015	5284.053.115

Wendemesser/Ersatzteile
Reversible knives/Spare parts

	Dim.	B	Art. Nr.
Wendemesser - <i>Reversible knife</i>	12x12x1,5		754.102
	14,6x9x1,5		750.090
	20x12x1,5		750.102
Spannkeil - <i>Clamping wedge</i>		20	707.001.18
		30	707.001.28
Gewindestift - <i>Screw</i>	M6x12		705.533
Torx Schraube - <i>Torx Screw</i>	M3,5x7,5		705.350
Sechskantschlüssel - <i>T Wrench</i>	SW3		706.103
Torx Schlüssel - <i>Torx Wrench</i>	T15		706.302
Einstell-Lehre - <i>Gauge</i>		1,0	717.302

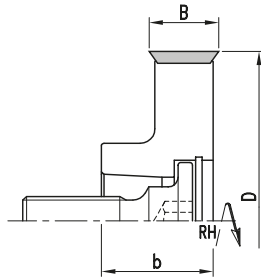
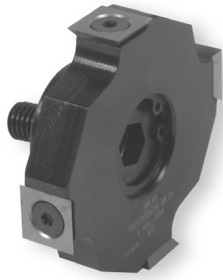
5102**HW Kantenfügefräser HSK25R - Wendemesser***TC Cutter HSK25R for edgebanding machines - Reversible knife***PG
02**

Zum Bündigfräsen oder Anfasen von Kantenanleimern.
For trimming or bevelling of edge bandings.

MEC**HW**

D	B/b	d	Z	n max	Art. Nr. LH	Art. Nr. RH
Homag - IMA						
70	14,3/23	HSK25R	4	18000	5102.070.014	5102.070.114

Wendemesser/Ersatzteile*Reversible knives/Spare parts*

	Dim.	Art. Nr.
Wendemesser - <i>Reversible knife</i>	14,3x14,3x2,5	750.116
Spannschraube - <i>Screw</i>	M5x13	705.320.13
Torx Schlüssel - <i>Torx Wrench</i>	T20	706.305
Spannschraube für HSK25R - <i>Screw for HSK25R</i>	M10x1,25	705.099

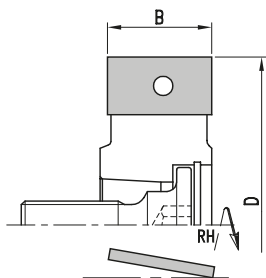
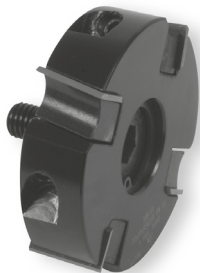
5602**HW Kantenfügefräser HSK25R - Wendemesser***TC Cutter HSK25R for edgebanding machines - Reversible knife***PG
02**

Zum Bündigfräsen oder Anfasen von Kantenanleimern.
For trimming or bevelling of edge bandings.

MEC**HW**

D	B	d	Z	n max	Art. Nr. LH	Art. Nr. RH
Homag - IMA						
70	24	HSK25R	4	18000	5602.070.024	5602.070.124

- Mit ziehendem Schnitt
- *Type with axial angle*

Wendemesser/Ersatzteile*Reversible knives/Spare parts*

	Dim.	Art. Nr.
Wendemesser - <i>Reversible knife</i>	24,7x12x1,5	750.103
Spannkeil - <i>Clamping wedge</i>		707.900.24
Gewindestift - <i>Screw</i>	M8x12	705.541
Sechskantschlüssel - <i>T Wrench</i>	SW4	706.104
Spannschraube für HSK25R - <i>Screw for HSK25R</i>	M10x1,25	705.099
Einstell-Lehre - <i>Gauge</i>	1,0	717.302

- Kantenfräser zum Abrunden, siehe Kapitel Fräswerkzeuge mit Bohrung, profiliert
- *Edge-Rounding cutter see chapter tools with bore, profiled*

