

ProChipper®

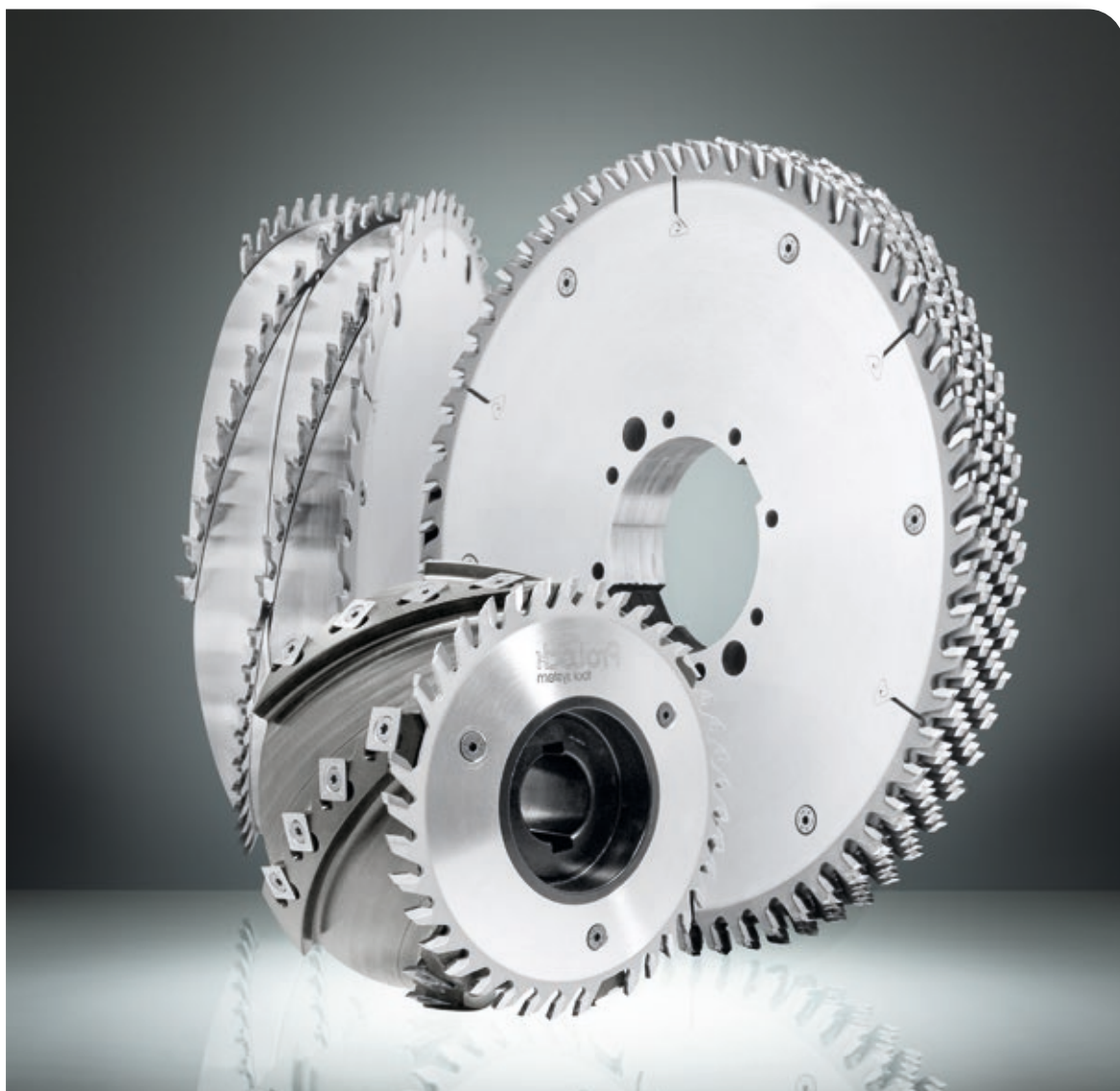

tooling systems



Zerspaner
Hoggers

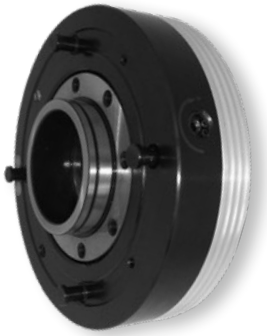

Hauptsächliche Verwendung für Zerspaner D250. Fräswerkzeuge mit Bajonettaufnahme zum Spannen auf FixMatic-Schnellspannsystemen sind auf Anfrage erhältlich.

Mainly used for hoggers D250mm. Milling tools with bayonet catches for mounting to FixMatic rapid clamping system available on demand.

FixMatic-Schnellspannsystem
FixMatic rapid clamping system

D	A	TKB	d	Art. Nr.
192	90	4/12/150	35 DKN	38.192.35
	97	4/12/150	40 DKN	38.192.40
	98,5	4/12/150	40 6kt.	38.192.41

Ersatzschrauben für Zerspanersägen - *Spare screws for hogger sawblades*

1 Beutel/bag 50Stck./pcs. M5 x 12/SK 9

0031.050.03

- FixMatic-Schnellwechselsystem für die Montage von Zerspanern, Fräswerkzeugen oder Kreissägeblättern. Das Schnellwechselsystem verfügt über fliehkraftbetätigte Zugbolzen. Der bei Maschinenstillstand vorgespannte Zugbolzen sorgt dafür, dass das Zerspanwerkzeug bei Maschinenstillstand spielfrei angezogen bleibt. Durch einfaches Drehen der Werkzeuglöseeinheit am vorgespannten Zugbolzen ist das Werkzeug schnell auswechselbar. Das System eignet sich für Links- und Rechtslauf. Der Einsatz ist an Maschinen mit Nenndrehzahlen vor 2800 U/min bis 9000 U/min vorgesehen.
- *FixMatic quick-clamping system for assembling cutters, hoggers and sawblades. The quick-clamping system has tie bolts operated by centrifugal force. A tie bolt which remains pretensioned at machine standstill ensures, that the tool remains pulled to the contact surface. Through turning the toolrelease unit, the tool can be changed quickly. The system can be used for left- and right hand rotation. The system is designed for use on machines with rated speeds of 2800 rpm to 9000 rpm.*

Segmentzerspaner mit FixMatic-Schnellspannsystem
Segmenthogger with FixMatic rapid clamping system

MEC

HW

D	Z	ZB	ZS	d	D-Säge	Art.Nr. LH	Art.Nr. RH
250	48	18	6xZ4	35 DKN	255	8037.250.048	8037.250.148
	48	18	6xZ4	40 DKN	255	8037.250.248	8037.250.348
	60	18	6xZ4	35 DKN	255	8037.250.060	8037.250.160
	60	18	6xZ4	40 DKN	255	8037.250.260	8037.250.360
	72	18	6xZ4	35 DKN	255	8037.250.072	8037.250.172
	72	18	6xZ4	40 DKN	255	8037.250.272	8037.250.372

- Segmentzerspaner zum ausrissfreien Längs- und Querzerspanen auf Doppelendprofilen
- *Segmenthogger for break-out-free cut edges when hogging along and across the grain with double-end tenoners*

Segmentzerspaner ohne FixMatic-Schnellspannsystem
Segmenthogger without FixMatic rapid clamping system

MEC

HW

D	Z	ZB	ZS	d	D-Säge	Art.Nr. LH	Art.Nr. RH
250	48	18	6xZ4	80	255	● 8037.250.448	8037.250.548
	60	18	6xZ4	80	255	● 8037.250.460	8037.250.560
	72	18	6xZ4	80	255	● 8037.250.472	8037.250.572

- auch passend für Leuco S-System 192
- *also suitable for Leuco S-System 192*
- Segmente gerade (Längsbearbeitung), oder für Stufenschnitt (Querbearbeitung) einstellbar
- *Segment adjustable, either for a straight (longitudinal) cut, or angled for a cross cut.*

8034

HW Segmentzerspamer - Für EF-Schnellwechselsystem

TC Segmenthogger - For EF-Quickchangesystem

PG
02

Zum ausrisfreien Längs- und Querspanen auf Doppelendprofilen
For break-out-free cut edges when hogging along and across the grain with double-end tenoners

MEC

HW

D	Z	ZB	ZS	d	Art.Nr. LH	Art.Nr. RH
255	48	18	6xZ4	80	8034.255.048	8034.255.148
	60	18	6xZ4	80	8034.255.060	8034.255.160
	72	18	6xZ4	80	8034.255.072	8034.255.172
	48	26	6xZ6	80	8034.255.248	8034.255.348
	60	26	6xZ6	80	8034.255.260	8034.255.360
305	72	26	6xZ6	80	8034.255.272	8034.255.372
	60	36	6xZ8	80	8034.305.060	8034.305.160
355	60	40	6xZ10	80	8034.305.260	8034.305.360
	54	30	6xZ8	80	8034.355.254	8034.355.354
430	54	36	6xZ10	80	8034.355.054	8034.355.154
	72	30	6xZ8	80	8034.355.072	8034.355.172
	72	36	6xZ10	80	8034.355.272	8034.355.372
430	72	30	6xZ8	80	8034.430.072	8034.430.172
	72	36	6xZ10	80	8034.430.272	8034.430.372

- Segmentzerspamer Aufbau-system, Zerspanungsbreite bis ca. 80mm.
- Segmente gerade (Längsbearbeitung), oder für Stufenschnitt (Querbearbeitung) einstellbar
- *Segmenthogger build-up system, hogging width until approx. 80mm.*
- *Segment adjustable, either for a straight (longitudinal) cut, or angled for cross cut.*

Segmentzerspamer ermöglichen, durch die Kombination mit unterschiedlichen Kreissägeblättern, die Bearbeitung folgender Werkstoffe:

- Rohe Holzwerkstoffe
- Beschichtete Holzwerkstoffe
- Verbundwerkstoffe

Durch den Einsatz von EF-Schnellwechselflanschen, lassen sich die Zerspamer einfach, ohne großen Kraftaufwand wechseln.

Segmenthoggers allow through combination with different sawblades, machining of following materials:

- Particle boards without coating
- Particle boards with coating
- Composite materials

By using EF-quickchange flanges, the change of hoggers is done easily and effortless.

8234

HW Segmentzerspamer-Verbreiterung - Für EF-Schnellwechselsystem

TC Segmenthogger extensions - For EF-Quickchange system

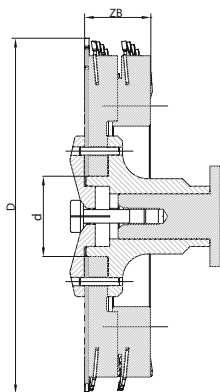
PG
02

HW Segmentverbreiterung für EF-System
TC Segment extension for EF-System

MEC

HW

D	ZB	ZS	d	Art.Nr. LH	Art.Nr. RH
250	18-36	6xZ4	80	8234.250.018	8234.250.118
	26-54	6xZ6	80	8234.250.036	8234.250.136
300	30-60	6xZ8	80	8234.300.030	8234.300.130
	36-72	6xZ10	80	8234.300.040	8234.300.140
350	30-60	6xZ8	80	8234.350.030	8234.350.130
	36-72	6xZ10	80	8234.350.040	8234.350.140
430	30-60	6xZ8	80	8234.430.030	8234.430.130
	36-72	6xZ10	80	8234.430.040	8234.430.140

Flanschbüchse mit Mitnahmestiften
Sleeve with lock pins

HW

D	d	d1	d2	L1	Maschine	Art.Nr. RH
98	25	40	40	40	Kontra	34.098.025
120	40	60	80	43,8	Siempelkamp	34.120.003
120	50	30	65	92,8	Dieffenbacher	34.120.006
120	40	60	80	27	Kontra	34.120.036
140	40	40	50	50	Kontra	34.140.040
145	115	35	35	18	Paul	34.145.008
160	28	30	30	89	Siempelkamp	34.160.026
160	50	80	80	52	Dieffenbacher	34.160.034
160	45	80	80	97,2	Dieffenbacher	34.160.002

- Flanschbüchse für Zerspaner Typ 8034
- *Sleeve for hogger type 8034*

EF Spannflansch
EF Quick change flange

HW

D	d	Typ	Maschine	Art.Nr. RH
98	40	3/4 M12	Kontra	36.098.041
120	60	3/5 M16	Kontra	36.120.063
120	60	3/5 M16	Siempelkamp	36.120.064
120	50	3/4,2 M12	Dieffenbacher	36.120.006
140	30	3/5 M16	Kontra	36.140.032
145	115	3/5 M16	Paul	36.145.115
160	60	3/5,4 M16	Dieffenbacher	36.160.004
160	60	3/6,2 M20	Dieffenbacher	36.160.006
160	30	3/6 M20	Siempelkamp	36.160.026

- EF-Schnellwechselflansch für Zerspaner Typ 8034
- *EF-Quickchange flange for hogger type 8034*

8274

HW Segmentzerspamer - Mit Flanschbüchse verschraubt TC Segmenthogger - Screwed with flange sleeve

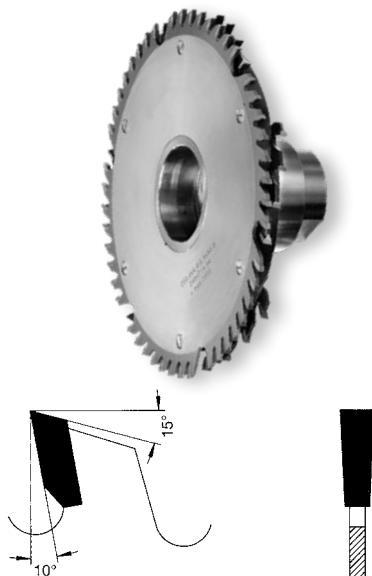
PG
02

Flachzahn
Flat tooth

Segmentzerspamer, verschraubt mit Flanschbüchse Segment hogger screwed with sleeve

MEC

HW

D	B	d	Z	Art.Nr LH	Art.Nr. RH
250	18	35 DKN	48F + 6x4	8274.250.018	8274.250.118
	26	35 DKN	48F + 6x6	8274.250.026	8274.250.126
	26	35 DKN	60F + 6x6	8274.250.226	8274.250.326
	18	40 DKN	48F + 6x4	8274.250.218	8274.250.318
	26	40 DKN	48F + 6x6	8274.250.426	8274.250.526
	26	40 DKN	60F + 6x6	8274.250.626	8274.250.726
	18	35 DKN	72F + 6x4	8274.250.418	8274.250.518
	18	40 DKN	72F + 6x4	8274.250.618	8274.250.718
300	30	35 DKN	60F + 6x8	8274.300.030	8274.300.130
	30	40 DKN	60F + 6x8	8274.300.230	8274.300.330
	30	35 DKN	72F + 6x8	8274.300.430	8274.300.530
	30	40 DKN	72F + 6x8	8274.300.630	8274.300.730
350	36	35 DKN	72F + 6x10	8274.350.036	8274.350.136
	36	40 DKN	72F + 6x10	8274.350.236	8274.350.336
	36	35 DKN	84F + 6x10	8274.350.436	8274.350.536
	36	40 DKN	84F + 6x10	8274.350.636	8274.350.736

4053

Ersatzsegmente - Für Segmentzerspamer Typ 8274, 8037, 8034, 8234 Spare segments - For segmented hogger type 8274, 8037, 8034, 8234

PG
02

Ersatzsegmente für Zerspamer Typ 0033+0834+0835 Spare segments for hogger type 0033+0834+0835

MEC

HW

D	Z	Art.Nr LH	Art.Nr. RH
200/250	4 mit Achsw.	4053.200.004	4053.200.104
	4 K		4053.200.204
250	4	4053.250.004	4053.250.104
	6	4053.250.006	4053.250.106
	8	4053.300.008	4053.300.108
	10	4053.300.010	4053.300.110
350/430	8	4053.350.008	4053.350.108
	10	4053.350.010	4053.350.110

730

Flanschbüchse Flange sleeve

PG
02

Starre Flanschbüchse Flange sleeve

MEC

HW

L1	L2	d	ML/TK	Art.Nr.
90	63	35 DKN	8/M8/100 Homag, IMA, Torwegge	730.101
97	68	40 DKN	8/M8/100 Schwabedissen, Gabbiani	730.102

Zubehör Attachment

Dim.	Art.Nr.
Schraube für Werkzeugmontage - Screw for tool mounting	M8x16 705.700.16
Ersatz-Schrauben für Zerspamersäge - Spare screws for hoggers	705.600.12

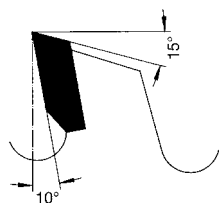

Flachzahn
Flat tooth

Ersatzsägen für Zerspaner Typ 8037+8034
Spareblades for segmenthogger type 8037+8034

MEC

HW

D	B	d	Z	ML/TK	Art.Nr LH	Art.Nr. RH
200	4,0	80	40 mit Aussp.	4/6/140	0032.201.40	0032.202.40
	4,0	80	60 mit Aussp.	4/6/140	0032.203.40	0032.204.40
220	4,0	80	60 mit Achsw.	6/6/154	0032.221.40	0032.222.41
	250	4,0	80	48 mit Achsw.	6/6/200	0032.250.08
4,0		80	72 mit Aussp.	6/6/200	0032.251.80	0032.250.80
	255	4,0	100	72 mit Aussp.	6/6/200	0032.251.10
4,0		80	48 mit Aussp.	6/6/200	0032.255.41	0032.256.41
	4,0	80	60 mit Aussp.	6/6/200	0032.257.41	0032.258.41
305		4,4	80	60	0032.305.02	0032.305.03
355	4,4	80	54	0032.355.05	0032.355.06	
	4,4	80	72 mit Aussp.	0032.355.07	0032.355.08	
430	4,4	80	72	0032.430.03	0032.430.04	

Unverbohrte Zerspanersägen
Not countersunk hoggerblades

MEC

HW

D	B	d	Z	Art.Nr.
205	4,0	80	44 F	0032.202.00
	4,0	80	60 F	0032.204.00
210	4,0	80	44 F	0032.212.00
	4,0	80	60 F	0032.214.00
255	4,0	80	48 F	0032.252.00
	4,0	80	60 F	0032.254.00
260	4,0	80	48 F	0032.268.00
	4,0	80	60 F	0032.268.00
4,0	80	72 F	0032.260.10	

- Unverbohrte Zerspanersägen zur Verbohrung auf diverse Zerspanersysteme.
- Verbohrungen und Aussparungen sind in den Preisen berücksichtigt.
Bei Bestellung bitte Zerspaner- Fabrikat angeben!

- *Not countersunk hoggerblades, to prepare for different hogger systems*
- *Pin holes and gaps are included in price. Hogger type must be specified.*

Ersatzsägen für Zerspaner Typ AKE
Spareblades for segmenthogger type AKE

MEC

HW

D	B	d	Z	ML/TK	Art.Nr LH	Art.Nr. RH
205	4,0	80	44 F	4/10/140	● 0032.201.01	0032.202.01
	4,0	80	60 F	4/10/140	● 0032.203.01	0032.204.01
255	4,0	80	48 F	6/10/190	● 0032.251.02	0032.252.02
	4,0	100	48 F	6/10/190	● 0032.255.01	0032.255.02
4,0	80	60 F	6/10/190	● 0032.253.02	0032.254.02	
4,0	100	60 F	6/10/190	● 0032.255.03	0032.255.04	

- Ersatzsägen für Segmentzerspaner Typ AKE
- *Spareblades for segmenthogger type AKE*

0033

Ersatzsegmente - Zerspanersystem AKE

Spare segments - Hogger type AKE

PG
02

Ersatzsegmente für Zerspanertyp AKE
Spare segments for hoggers type AKE

MEC

HW

Art.Nr.

Ausführung mit Gewindestift - With setscrew

1 Pack. = 12 St. Segmente mit Gewindestift / segments with setscrews	0033.012.01
1 Pack. = 12 St. ungeschliffen für Foldingzerspaner / unground for folding-type hogger	0033.013.01
1 Pack. = 24 St. Gewindestifte / setscrews	0033.024.02

38

FixMatic®-Schnellspannsystem

Fixmatic® rapid clamping system

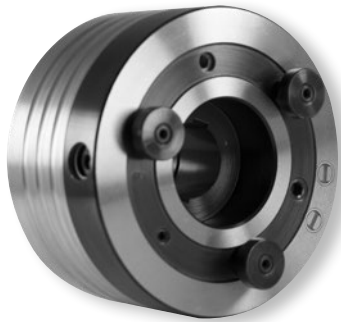
PG
02

FixMatic-Schnellspannsystem
Fixmatic rapid clamping system

MEC

HW

D	A	TKB	d	Art.Nr.
122	68	3/20/80	30DKN	38.122.30
	86	3/20/80	35DKN	38.122.35
	99,5	3/20/80	40 6kt.	38.122.40

- FixMatic-Schnellwechselsystem für die Montage von Fräsworkzeugen oder Kreissägeblättern. Das Schnellwechselsystem verfügt über fliehkraftbetätigte Zugbolzen. Der bei Maschinenstillstand vorgespannte Zugbolzen sorgt dafür, dass das Zerspanwerkzeug bei Maschinenstillstand spielfrei angezogen bleibt. Durch einfaches Drehen der Werkzeuglöseeinheit am vorgespannten Zugbolzen ist das Werkzeug schnell auswechselbar. Das System eignet sich für Links- und Rechtslauf. Der Einsatz ist an Maschinen mit Nenndrehzahlen vor 2800 U/min bis 9000 U/min vorgesehen.
- *FixMatic quick-clamping system for assembling cutters and sawblades. The quick-clamping system has tie bolts operated by centrifugal force. A tie bolt which remains pre-tensioned at machine standstill ensures, that the tool remains pulled to the contact surface. Through turning the tool release unit, the tool can be changed quickly. The system can be used for left- and right hand rotation. The system is designed for use on machines with rated speeds of 2800 rpm to 9000 rpm.*

38

HW Vorritzkreissägeblatt - Mit FixMatic®-Schnellspannsystem

TC scoring sawblade - With Fixmatic® rapid clamping system

PG
02

Vorritzsäge mit Flansch und FixMatic-Schnellspannsystem
Scoring blade with flange and Fixmatic rapid clamping system

MEC

HW

D	B	d	Z	d-FixMatic	Art.Nr. LH	Art.Nr. RH
180	3,2	50	30	30 DKN	38.180.31	38.180.32
		50	30	40 6kt.	38.180.40	38.180.41
		50	42	30 DKN	38.181.31	38.181.32
		50	42	40 6kt.	38.181.40	38.181.41
		50	54	30 DKN	38.182.31	38.182.32
200	3,2	50	54	40 6kt.	38.182.40	38.182.41
		50	48	30 DKN	38.200.31	38.200.32
	3,2	50	60	30 DKN	38.201.31	38.201.32

Vorritzsäge mit Flansch und FixMatic-Schnellspannsystem
Scoring blade with flange and Fixmatic rapid clamping system

MEC

HW

D	B	b	d	Z	ML/TK	Art.Nr. LH	Art.Nr.
180	3,2	2,2	50	30	3/22/80		0030.180.51
		2,2	50	42	3/22/80		0030.180.50
		2,2	50	54	3/22/80		0030.180.52
200	3,2	2,2	50	48	3/22/80		0030.200.51
		2,2	50	60	3/22/80		0030.200.53
110	KSB-Innenmontage zwischen Flansch					38.110.49	38.110.50
110	KSB-Außenmontage vor Flansch					38.110.51	38.110.52





Zum Vorritzen im Gleichlauf
 (1 Garnitur = 1 Satz links und rechts)
 (1 complete set = 1 right-hand set and
 one left-hand set)

Ritzgarnitur mit Flanschbüchse
Scoring set with flange sleeve

MEC

HW

D	B	b	d	Z	Art.Nr. LH	Art.Nr. RH
150	3,2	2,2	30 DKN	30F	8030.150.030	8030.150.130
180	3,2	2,2	30 DKN	42F	8030.180.042	8030.180.142
180	3,2	2,2	30 DKN	54F	8030.180.054	8030.180.154

Ersatz-Sägeblätter
Replacement saws

MEC

HW

D	B	b	d	ML/TK	Z	Art.Nr. LH	Art.Nr. RH
150	3,2	2,2	65	6/5,5/90	30F	0030.150.04	0030.150.05
180	3,2	2,2	65	6/5,5/90	42F	0030.180.08	0030.180.09
180	3,2	2,2	65	6/5,5/90	54F	0030.180.06	0030.180.07

Ersatz Flanschbüchse
Spare sleeve

MEC

HW

D	d	Art.Nr. RH
108	30DKN	730.109

Ersatz-Sägeblätter
Replacement saws

MEC

HW

Bezeichnung	Art.Nr. RH
Torx-Schraube M5x12 D=9 1VE=50St.	705.819
Torx-Schraube M5x12 D=10 1VE=50St.	705.829
Torx T-Griff Schlüssel T20	81.100.20

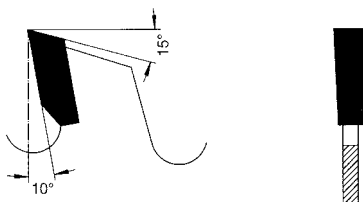

Flachzahn
Flat tooth

Zum Vorritzen von Plattenwerkstoffen
For scoring of panel boards

MEC

HW

D	B	b	d	Z	ML/TK	Art.Nr.
150	3,2	2,2	30	30		0030.150.30
						0030.150.31
180	3,2	2,2	30	30		0030.180.34
						0030.180.33
						0030.180.31
						0030.180.51
200	3,2	2,2	30	36		0030.200.30
						0030.200.31
						0030.200.33
						0030.200.51
305	3,2	2,2	30	54	3/22/80+3/6/80	0030.200.51
						0030.200.53
355	4,4	3,0	30	72		0030.355.30

- Passend für Schnellwechselsystem
- Fits to quick change system
- Verbohrung für verschiedenste Ritzbüchsen auf Anfrage möglich
- Possible drilling pattern for different mounting flanges on demand

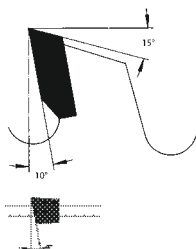
Zum Formatieren von Holzwerkstoffen
For sizing of timber products

MEC

HW

D	B	d	ML/TK	Z	Art. Nr. LH	Art. Nr. RH
250	16,5	80	4/M8/100	48/12/6	8634.250.017*	8634.250.117 *
	16,5	80	4/M8/100	60/12/6	8634.250.217*	8634.250.317 *
250	22,5	80	4/M8/100	48/12/6/6	8634.250.023	8634.250.123 *
	22,5	80	4/M8/100	60/12/6/6	8634.250.223	8635.250.323 *
255	14,4	40		48/12/6	8634.255.014	8634.255.114 ●
255	14,4	35		48/12/6	8634.255.214	8634.255.314 ●
255	14,4	40		60/12/6	8634.255.414	8634.255.514 ●
255	14,4	35		60/12/6	8634.255.614	8634.255.714 ●

* Aufbauzerspaner zur Montage auf Flanschbüchse
Build up hogger for installation on flange sleeve

- Passend für Schnellwechselsystem
Fits to quick change system

Ersatzsägen mit Achswinkel
Spare sawblades with axial angle

MEC

HW

D	B	b	d	ML/TK	Z	Art. Nr. LH	Art. Nr. RH
250	5,5	5,0	30	12/6/190	12	0032.250.81	0032.250.82
255	7,0	5,0	30	12/6/190	6	0032.255.85	0032.255.84
	4,0	2,8	3048	12/6/190	48	0032.255.81	0032.255.80
	4,0	2,8	3060	12/6/190	60	0032.255.83	0032.255.82



- Weitere Abmessungen auf Anfrage. Wir fertigen Aufbauzerspaner bis Durchmesser 1000mm. Ausführung zum Zerspanen von Spanplattenpaket-Reststreifen von links bzw. von rechts mit einem Zerspaner.
- Further dimensions on demand. We produce hoggers until diameter 1000mm. Layout for hogging left and right side of panel stacks with one hogger.

8930
HW/HS Eckenspaner - Für Profilieraggregate
TC/HS Grooving chipper - For profiler units
**PG
02**
Sägewerks-Profiliergarnitur
Saw mill profiling tool set
MEC HW/HS

D	Z	ZB	ZS	Art. Nr. LH	Art. Nr. RH
350	12	120	4x2	8930.350.012	8930.350.112
400	14	147	5x2	8930.400.014	8930.400.114
490	48	120	4xZ2	8930.490.048	8930.490.148
490	54	120	4xZ3	8930.490.054	8930.490.154

- Modulares Aufbausystem zur Herstellung der Seitenbrettschmalseite am vorgespannten Rundholz oder Model.
- Bis max. 100m/min Vorschub sind 2 Spanermesser (Wendemesser Z=2) am Werkzeugumfang im Einsatz. Die Ausführung mit 3 Spanermessern ist für höhere Vorschübe.

- *Modular Build-up system to edge the side boards.*
- *Up to 100m/min, 2 chipper knives (Indexable knives Z=2) are mounted on the tool diameter. The type with 3 chipper knives is for higher feedrates.*

222
Ersatz Hackmesser- Für Spaner Typ 8930
Spare chipper knives - For chipper type 8930
**PG
02**
Ersatz-Hackmesser
Spare chipper knives
MEC HS

L	B	Z	Zng. Nr.	Art. Nr.
60	30	2	8930.350.031/8930.400.011	222.060.001
55	30	1	8960.400.001	222.055.035
55	30	1	8960.400.004	222.055.036
55	30	2	8930.490.033	222.055.030
76	35	1	V25-24-390	222.035.076
55	30	2	229585/229586	222.120.090

- Weitere Hackmesser auf Anfrage
- *Further chipper knives on demand*

8960
HS Nachschnittspaner
HS Recut hogger
**PG
02**
Sägewerks-Nachschnittspaner
Saw mill recut hogger
MEC HS

D	Z	ZB	ZS	Art. Nr. LH	Art. Nr. RH
400	24	55	2xZ2	8960.400.024	8960.400.124

- Modulares Aufbausystem zur Einsparung eines "Rundlaufs" an Bauholzl原因en.
- Einsatz als Nachschnitt-Zerspaner bei direktem Durchlauf von Schwachholz.

- *Modular Build-up system to reduce the merry-go-round system in sawlines.*
- *Application as recut for direct processing of small diameters in one pass.*



8033
8833

HW Spaner-Segmente - Für Sägewerks-Messerköpfe
TC Chipper segments - For sawmill industry chipper units

PG
02

Spanerring für Typ 8930
Chipper ring for type 8930

MEC

HW

D	B	b	Z	Typ	R/L	Art. Nr. RH
490	9,0	7,0	48	8930	L	8833.490.048
490	9,0	7,0	48	8930	R	8833.490.148
490	9,0	7,0	54	8930	L	8833.490.054
490	9,0	7,0	54	8930	R	8833.490.154

Spanersegmente für EWD
Chipper ring for type 8930

MEC

HW

D	B	b	d	Z	Typ	tlg	Art. Nr. RH
360	4,8	3,6	132	12	3-Y247190	2	8033.360.012
360	4,8	3,6	184	12	3-Y247894	2	8033.360.112
500	5,0	3,8	184	16	3-Y247031-04A	2	8033.500.016
555	5,8	5,0	450	12	2-234368	4	8033.555.012
555	6,2	5,0	450	15	2-Y218954-06	4	8033.555.015
555	6,2	5,0	450	15	2-Y218954-07	4	8033.555.115
555	5,8	5,0	450	19	218954	3	8033.555.019
555	6,2	5,0	450	19	218954	3	8033.555.119
555	5,8	8,0	450	19	235612	3	8033.555.219

Zerspanerringe für EWD
Chipperrings for EWD

MEC

HW

D	B	b1	b2	d	Z	Typ	R/L	Art. Nr. RH
530	6,4	5,0		355	60	PF 19-4,236598-05		8033.530.060
530	6,5	5,0		355	76	236-598-05		8033.530.076
620	5,2	4,0		450	45	2-Y247915	R	8033.620.045
620	5,2	4,0		450	45	2-Y247916	L	8033.620.145
620	5,7	4,5		450	50	2-Y248242	R	8033.620.050
620	5,7	4,5		450	50	2-Y248243	L	8033.620.150
620	5,0	3,8		450	57	2-246793	R	8033.620.057
620	5,0	3,8		450	57	2-246794	L	8033.620.157
745	6,6	5,0	6,0	520	60	PF19-3,0-236598-20B	L	8033.745.060
745	6,6	5,0	6,0	520	60	PF19-3,0-236598-21B	R	8033.745.160
745	6,6	5,0	6,0	520	60	PF19-4,0-457405-03A	L	8033.745.260
745	6,6	6,0		520	60	PF19-4,0-457405-02A	R	8033.745.360
745	6,6	5,0		520	60	PF19-6,0-236598-13B	L	8033.745.460
745	6,6	5,0		520	60	PF19-6,0-236598-14B	R	8033.745.560
755	6,4	5,0		520	57	0-236598-21	R	8033.755.057
755	6,4	5,0		520	57	0-236598-20	L	8033.755.157
755	6,4	5,0		520	54	0-236598-13	R	8033.755.054
755	6,4	5,0		520	54	0-236598-14	L	8033.755.154





Spanersegmente für Linck
Chipper segments for Linck

MEC

HW

D	B	b1	b2	d	Z	Typ	R/L	Art. Nr.
401	3,5	2,5	8,0	200,4	10	VPS 28-05A2	L	8033.401.010
401	3,5	2,5	8,0	200,4	10	VPS 28-053A	R	8033.401.110
403	3,5	2,5	5,0	305	7	VP 34-08068	L	8033.403.007
403	3,5	2,5	5,0	305	7	VP 34-08-069	R	8033.403.107
403	3,5	2,5	5,0	305	8	VP 34-08-055	L	8033.403.008
403	3,5	2,5	5,0	305	8	VP 34-08-056	R	8033.403.108
411	4,0	3	5,0	317	7	VP 48-08-029	L	8033.411.007
411	4,0	3	5,0	317	7	VP 48-08-028	R	8033.411.107
411,50	3,5	2,5	8,0	210	10	VP 48-08-144	L	8033.412.010
411,50	3,5	2,5	8,0	210	10	VO 48-08-145	R	8033.412.110
413,50	3,5	2,5	7,0	170	9	VP 48-08-168	L	8033.414.009
413,50	3,5	2,5	7,0	170	9	VP 48-08-167	R	8033.414.109
413,50	3,5	2,5	7,0	202,4	9	VP 48-08-162	L	8033.414.209
413,50	3,5	2,5	7,0	202,4	9	VP 48-08-163	R	8033.414.309
415	3,5	2,5	8,0	210	10	VP 48-08-104		8033.415.010
415	3,5	2,5	8,0	210	10	VP 48-08-105		8033.415.110
415	3,5	2,5	8,0	210	11	VP 48-08-075	L	8033.415.011
415	3,5	2,5	8,0	210	11	VP 48-08-076	R	8033.415.111
415	8,0	7		200,4	15	VP 48-08-065	L	8033.415.015
415	8,0	7		200,4	15	VP 48-08-064	R	8033.415.115
497	3,5	2,5	8,0	200,4	8	VPS 28-083	L	8033.497.008
497	3,5	2,5	8,0	200,4	8	VPS 28-082	R	8033.497.108
497	3,5	2,5	8,0	200,4	8	VPS 28-146	L	8033.497.208
497	3,5	2,5	8,0	200,4	8	VPS 28-145	R	8033.497.308
566	5,0	4,0		160	36	VPM- 08-035		8033.566.036
570	4,5	3,4	5,0	450	19	V 25-08-023	L	8033.570.019
570	4,5	3,4	5,0	450	19	V 25-08-022	R	8033.570.119
730	4,5	3,5		588	13	VM 30-24-010	L	8033.730.013
730	4,5	3,5		588	13	VM 30-24-009	R	8033.730.113
830	4,5	3,5	5,0	710	17	V 40-19-1612	L	8033.830.017
830	4,5	3,5	5,0	710	17	V40-19-1611	R	8033.830.117
850,55	4,5	3,5		697	13	VM 30-24-085	L	8033.851.013
850,55	4,5	3,5		697	13	VM 30-24-08		8033.851.113
854,20	4,7	3,5		697	14	V 40-41-118	L	8033.854.014
854,20	4,7	3,5		697	14	V 40-41-117	R	8033.854.114



Zerspanerringe für Linck
Chipperrings for Linck

MEC

HW

D	B	b1	b2	d	Z	Typ	R/L	Art. Nr.
490	4,5	3,5	6,0	394	42	VM 35-24-004	L	8033.490.042
490	4,5	3,5	6,0	394	42	VM 35-24-003	R	8033.490.142
490	4,5	3,5	6,0	394	40	VM 35-24-024	L	8033.490.040
490	4,5	3,5	6,0	394	40	VM 35-24-023	R	8033.490.140
579	4,5	3,5	6,0	422	51	V25-24-432	L	8033.579.051
579	4,5	3,5	6,0	422	51	V25-24-431	R	8033.579.151
724	4,5	3,5	6,0	586	64	VM30-24-559	L	8033.724.064
724	4,5	3,5	6,0	586	64	VM30-24-558	R	8033.724.164
850	5,5	4,5	6,0	695	78	VM30-24-540	L	8033.850.078
850	5,5	4,5	6,0	695	78	VM30-24-539	R	8033.850.178
858	4,5	3,5	6,0	695	78	VM30-24-402	L	8033.858.078
858	4,5	3,5	6,0	695	78	VM30-24-401	R	8033.858.178
858	4,5	3,5	7,4	695	72	V40-41-450	L	8033.858.072
858	4,5	3,5	7,4	695	72	V40-41-449	R	8033.858.172
858	4,5	3,5	7,4	695	60	V 40-41-474	L	8033.858.060
858	4,5	3,5	7,4	695	60	V 40-41-473	R	8033.858.160



